

POWER ACOUSTIK

PD-344 / PD-344T

PD-344B / PD-344BT

Flip-down/Detachable 3.4" Monitor

DVD/CD/MP3/MP4 Player

AM/FM Radio

Built-in TV tuner(only for PD-344T /PD-344BTmodel)

Support Bluetooth(only forPD-344B /PD-344BTmodel)

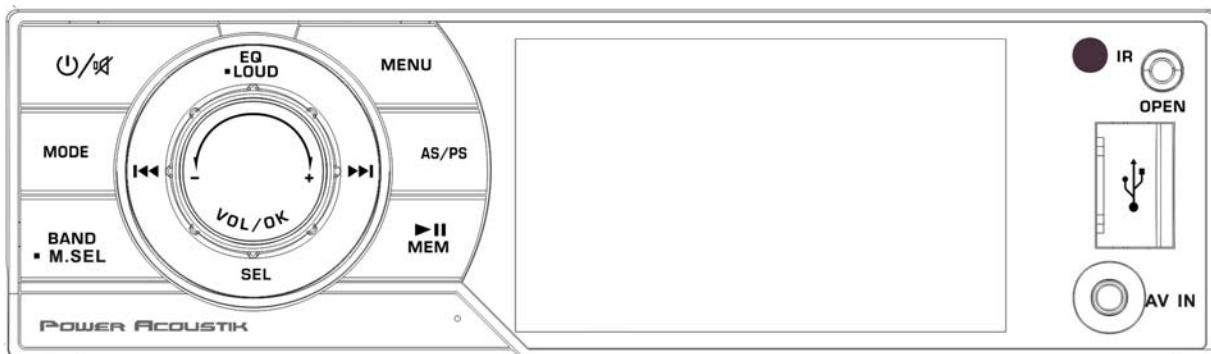

Owner's Manual

Take the time to read through this owner's manual.

Familiarity with installation and operation procedures will help you obtain the best Performance from your new DVD-receiver.

Important Safeguards







- Using the device at temperature below -10°C may cause the breakage of the device. BEFORE USING PLEASE HEAT UP THE PASSENGER COMPARTMENT TO THE RECOMMENDED TEMPERATURE!
- Read carefully through this manual to familiarize you with this high-quality sound system.
- Disconnect the vehicle's negative battery terminal while mounting and connecting the unit.
- When replacing the fuse, be sure to use one with an identical amperage rating. Using a fuse with a higher amperage rating may cause serious damage to the unit.
- DO NOT attempt to disassemble the unit. Laser beams from the optical pickup are dangerous to the eyes.
- Make sure that pins or other foreign objects do not get inside the unit; they may cause malfunctions, or create safety hazards such as electrical shock or laser beam exposure.
- If you have parked the car for a long time in hot or cold weather, wait until the temperature in the car becomes normal before operating the unit.
- DO NOT open covers and do not repair yourself. Consult the dealer or an experienced technician for help.
- Make sure you disconnect the power supply and aerial if you will not use the system for a long period or during a thunderstorm.
- Make sure you disconnect the power supply if the system appears to be working incorrectly, (For example: making unusual sounds, smelling strange, emitting smokes from inside or liquid having gotten inside it) Have a qualified technician check the system.
- The unit is designed for negative terminal of the battery, which is connected to the vehicle metal. Please confirm it before installation.
- Do not allow the speaker wires to be shorted together when the unit is switched on. Otherwise it may overload or burn out the power amplifier.
- Do not install the detachable panel before connecting the wire.
- Don't remove the detachable panel when encoding.

Contents

Important Safeguards.....	2
Contents.....	3
Accessories.....	4
Installation/Un-Installation	5
Wiring Connections	6
Front panel.....	7
Inner panel	7
Remote control.....	8
Remove battery.....	8
Main Menu	9
General Operation	9
Radio operation.....	13
DVD/USB/SD/MMC Operation.....	14
TV Operations(Only for PD-344T /PD-344BTmodel)	17
Bluetooth Section(Only for PD-344B/PD-344BTmodel)	18
Anti-theft system	20
Handling & Cleaning DISC.....	20
Troubleshooting guide	21
Specification.....	22

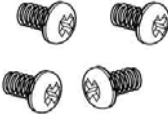
Accessories

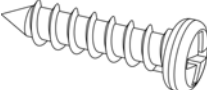
Package contains the following accessories for installation and operation of the unit.

(1) Washer, Spring Washer, M5 Nut	1 each	
(2) Mounting Strap	1	
(3) Bolt 5*20	1	
(4) Screw 5*6	4	
(5) Mounting Collar	1	
(6) Release Key	2	
(7) Screw 5*20	1	
(8) Rubber Cushion	1	



Remote Control

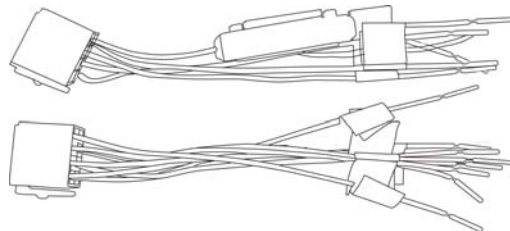

ISO cable



Warranty card



User Manual



Trim ring



1x front panel protection case

Note:
Product image may vary from the actual delivery.

Installation/Un-Installation

First complete the electrical connections, and then check them for correctness.

Installation

This unit can be installed in any dashboard having an opening as shown on the picture. The dashboard should be 4.75 – 5.56 mm thick in order to be able to support the unit.

1. Insert mounting collar into the dashboard, and bend the mounting tabs out with a screwdriver.

Make sure that lock lever (※) is flush with the mounting collar (not projecting outward).

2. Secure the rear of the unit.

After fixing mounting bolt and power connector, fix the rear of the unit to the car body by rubber cushion.

3. Insert trim plate.

When you prepare to insert trim plate, please check its direction. Once it was up side down, it cannot be fixed.

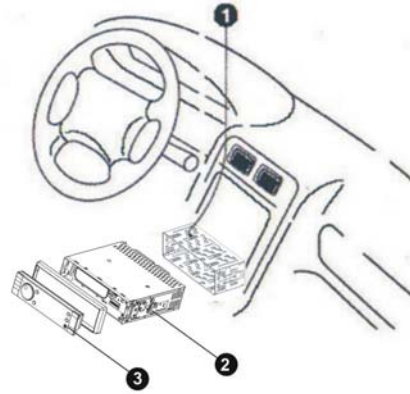

Lock lever (※)

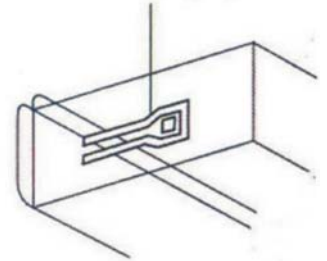

Un-installation

Remove Trim Ring and insert Release Keys into left and right side-end holes as shown in below picture and pull the unit out of the dashboard.

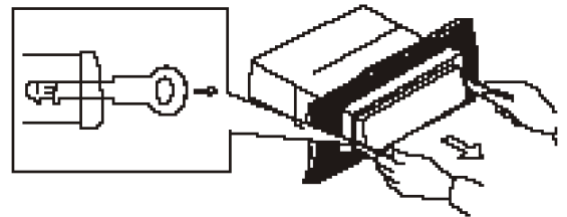

Wiring Connections

Make sure you have good chassis ground. A good ground connection will eliminate most electrical noise problems. A good chassis ground requires a tight connection to the vehicle's metal chassis. The area around the ground connection should be clean, bare metal without rust, paint, plastic, dust, or dirt for a good electrical connection.

Caution: Do not interchange the connection of the wiring!!! For some car models you may need to modify wiring of the supplied power cord. Contact your authorized car dealer before installing this unit.

Using the ISO Connector

1. If your car is equipped with the ISO connector, then connect the ISO connectors as illustrated.
2. For connections without the ISO connectors, check the wiring in the vehicle carefully before connecting, incorrect connection may cause serious damage to this unit.
3. Cut the connector; connect the colored leads of the power cord to the car battery as shown in the color code table below for speaker and power cable connections.

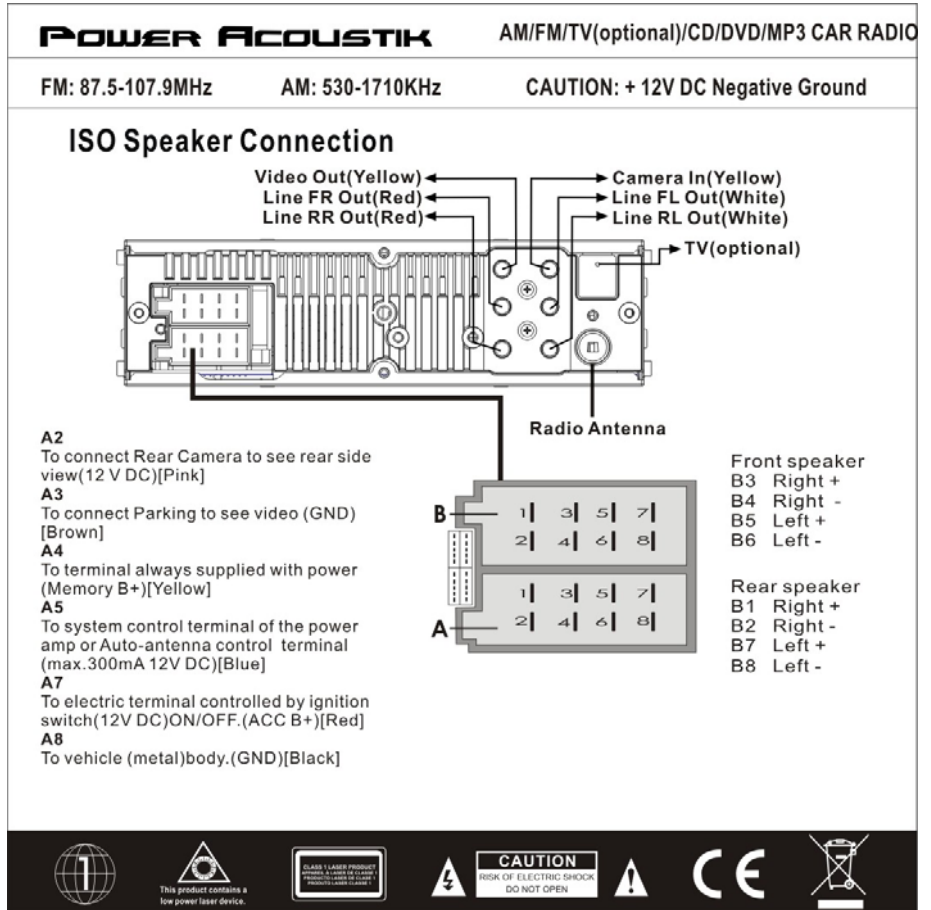

Location	Function	Connector A	Connector B
		Connector A	Connector B
1			Rear Right(+)--Purple
2	Camera (12V DC)--Pink		Rear Right(-)--Purple/Black Stripe
3	Parking (GND)--Brown		Front Right(+)--Grey
4	Battery 12V (+)--Yellow		Front Right(-)--Grey/Black Stripe
5	Auto Antenna--Blue		Front Left(+)--White
6			Front Left(-)--White/Black Stripe
7	ACC(+)--Red		Rear Left(+)--Green
8	Ground--Black		Rear Left(-)--Green/Black Stripe

Front panel

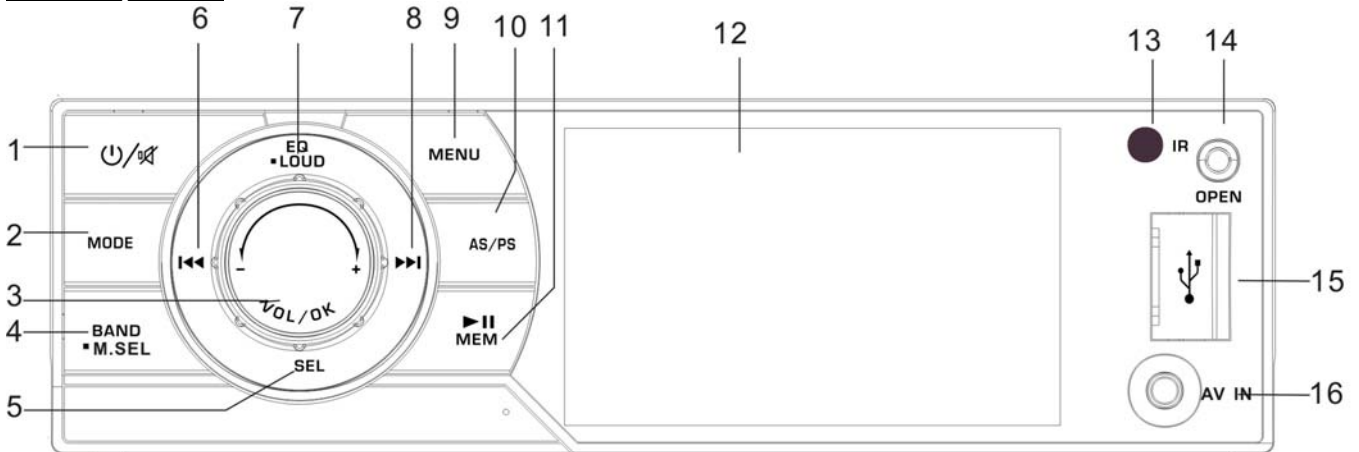

- | | |
|-------------------------------|-------------------------------|
| 1) Power /Mute button | 9) MENU button |
| 2) Mode button | 10) AS/PS button |
| 3) Volume/OK button | 11) Play/Pause, Memory button |
| 4) BAND / Media select button | 12) LCD Screen |
| 5) SEL button | 13) IR sensor |
| 6) Previous / Reverse button | 14) OPEN button |
| 7) EQ /LOUD button | 15) USB slot |
| 8) Next / Forward button | 16) AV IN jack |

Inner panel

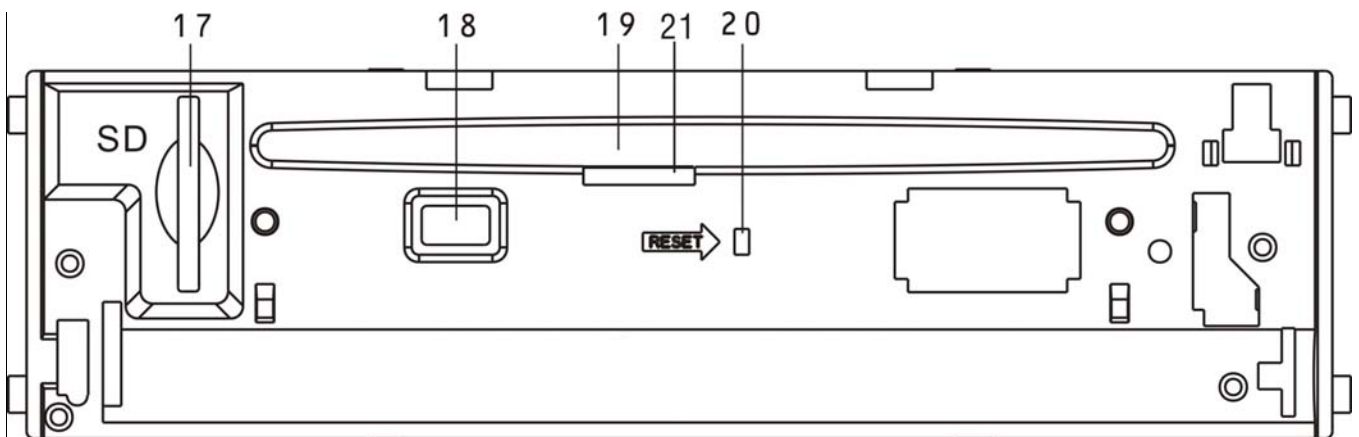

- | |
|--------------------------|
| 17) SD/MMC card slot |
| 18) Eject button |
| 19) Disc loading slot |
| 20) Reset button (hole) |
| 21) Anti-Theft LED flash |

NOTE: When turn off the power, the unit will switch to standby mode unless cut the ACC power. The power light will continue lighting.

Remote control

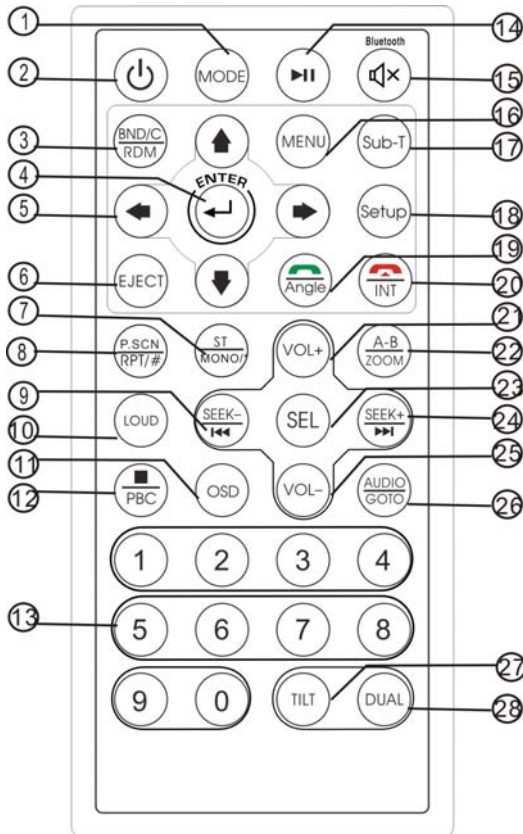

- 1: MODE
- 2: POWER
- 3: BAND/RANDOM/Clear(Optional)
- 4: ENTER
- 5: UP/DOWN/LEFT/RIGHT
- 6: EJECT(Option without function)
- 7: STEREO/MONO/(Optional)
- 8: P.SCN/RPT/#(Optional)
- 9: BACKWARD/SEEK-FAST BACKWARD
- 10: LOUD
- 11: OSD
- 12: PBC/STOP
- 13: Digit numbers
- 14: Play/Pause
- 15: Mute/Bluetooth (Optional)
- 16: MENU
- 17: SUBTITLE
- 18: SETUP
- 19: ANGLE/Accept (Optional)
- 20: INT/Eject(Optional)
- 21: VOLUME PLUS
- 22: A-B/ZOOM
- 23: SEL
- 24: FORWARD/SEEK+FAST FORWARD
- 25: VOLUME MINUS
- 26: AUDIO/GOTO
- 27: TILT (Option without function)
- 28: DUAL

Noted: The RC is the universal and full-featured. Some options are available with the corresponding model.

Remove battery

Note:

- The distance may vary according to the brightness of ambient light.
- If the remote is not used for an extended period of time, remove the battery to prevent possible damage from battery leakage and corrosion.
- Do not place any objects between the remote control unit and the sensor on the unit.
- Do not drop the remote control onto the floor; it will damage it beyond repair.
- Do not use the remote control unit, while simultaneously operating the remote control unit of any other equipment; they may interfere resulting in improper operation.
- The battery normally last for about one year although depending how often the remote control is used. If the remote control unit isn't working even when it is operated near the unit, replace the battery with a new battery of the same make and use only a lithium cell battery type: CR2025 (3V).
- Dispose empty batteries in accordance with your local governmental regulations.
- Do not short-circuit, disassemble, heat or dispose of fire or flames the battery.
- Keep the battery out of reach of children, should the battery be swallowed, immediately consult a doctor.

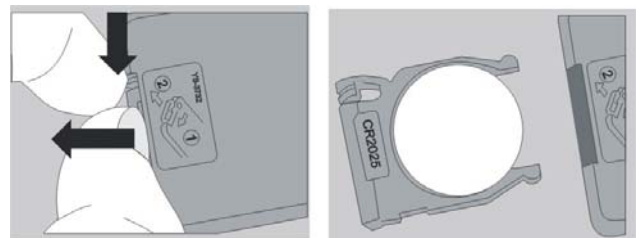

Main Menu

The best way to discover the program is to explore each screen in detail, and to find out how to move from one to another. Read this chapter for a guided tour.

Unit starts by displaying the Main menu.

This is the root of the screen hierarchy, you can simply take knowledge of the features.



General Operation

Reset the unit

Operating the unit for the first time or after replacing the car battery, you must reset the unit. Press OPEN button on the panel to open the panel and press RESET button to restore the unit to its original factory settings.

Power on or off

Press any button (except open button) to turn on the unit.

Long press POWER button on front panel or press power button on the RC to power off the unit..

Mode setting

Press the MODE button repeatedly to switch between inputs:

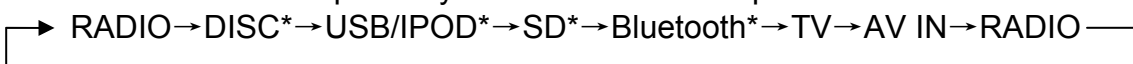

(* available only if there is media device in disc, SD, USB slot and Bluetooth connection is OK.)

Volume/OK

Adjust the volume level by turning the VOL knob on the panel clockwise to increase or counterclockwise to decrease or pressing VOL+ or /VOL- on the RC to increase or decrease the volume.

In any mode, rotate VOL knob to select the file you want to playback, press the OK button to enter the next menu.

Sound Adjustments

Press the SEL button on the RC or front panel to select the audio settings consisting of following items:

EQ: Select the digital sound effect FLAT→CLASSIC→POP→ROCK→USER.

BASS: Bass up/down.

TREBLE: Treble up/down.

BALANCE: Left/right Balance control.

FADER: Front/rear Fader control.

BEEP: Keypad sound setting.

LOUDNESS: Set the loudness on or off.

Rotate Volume knob on the front panel or press up/down arrow on the RC to select any items and then press OK button on the panel or Enter button on the RC to confirm the item.

Rotate Volume knob or press LEFT/RIGHT buttons on the RC to adjust the audio setting. Press OK button on the panel or Enter button on the RC to confirm and again press SEL button return to current mode.

Note:

- ✧ If the unit is turned off, all the settings of each mode will be saved.
- ✧ If cutting off battery power or resetting the unit, all the settings will return to factory default settings.
- ✧ When EQ is set to any mode (except USER mode), Bass and Treble are not adjustable.

Mute function

Press POWER/MUTE button on the panel or MUTE button on the RC to turn the sound off. Press it again to resume the volume.

Loudness

Press LOUD button on RC or long press the LOUD button on the front panel to set loudness or off.

EQ

Short press the EQ button on the panel to choose sound effect in the sequence of FLAT→CLASSIC→POP→ROCK→EQ OFF.

Menu

Press **Menu** button to show main menu. In DVD mode press and hold for two seconds to enter title menu (Enable only if the DVD disc with title menu).

Setup

Press SETUP button on the RC or SETTING icon on the main menu to go to setup pages.

- 1) Rotate Volume knob on the front panel or press up/down arrow on the RC to select any items and then press OK button on the panel or Enter button on the RC to confirm the item
- 2) Rotate Volume knob or press LEFT/RIGHT buttons on the RC to adjust the audio setting. Press OK button on the panel or Enter button on the RC to confirm.
- 3) Press SETUP button again return to current mode.

Sound

	EQ: select the digital sound effect.
	BASS: bass up/down.
	Treble: treble up/down.
	Balance: Left/right Balance control.



FADER: Front/rear Fader control.

BEEP: Select keypad sound on or off.

LOUDNESS: Selecting loudness ON will emphasize the low frequency output.

Display



Screen: screen ratio control

Backlight: set the LCD screen backlight.

General



Dual: dual function control(if you need)

Key: current/DVD(if you need)

Clock display: Select ON (clock is displayed) OFF (clock is not displayed).

Clock hour: select 12-hour or 24-hour clock display mode.

Clock setting: Press number buttons to input the current time.

Auto connect: set Bluetooth automatically connect to previous paired device or not (only for PD-344B/PD-344BT).

Radio



Area: Select radio broadcasting area.

Stereo: Select ON (stereo reception mode) or OFF (mono reception).

DVD



[1].Subtitle Lang setting:

With this option you can select the preferred language for the subtitles. When the selected language is recorded on the disc then this language will automatically be shown. If not, the first language recorded on the disc is displayed.

[2].Audio Lang setting:

With this option you can select the preferred language for the audio output. When the selected language is recorded on the disc (not all discs have multiple languages recorded) then this language will automatically be played. If not, the first language recorded on the disc is displayed.

[3]. DVD Menu Lang setting:

With this option you can select the preferred language for the disc menu. When the selected language is recorded on the disc then this language will automatically be selected. If not, the first language recorded on the disc is displayed.

[4]PASSWORD:

The password for this unit is initially set to factory default 0000. If you want to change your password, you need to enter the old password first and confirm it, and enter a new password and confirm. **WARNING:** if you forget your password, there is no possibility to reset the password again. Do not forget your mask and write it down or store the mask in a safe place.

[5] Rating / PARENTAL SETUP.

For DVD discs which support the USA rating system, setting up rating control can prevent children from watching content that might not be suitable for their age. You are asked to enter the password when you change the rating setting. The default password is 0000.

Code	Description
1.NONE	Kid safe
2.G	General Audiences – ALL ages admitted
3.PG	PARENTAL GUIDANCE SUGGESTED-Some material may not be suitable for children
4.PG-13	PARENTS STRONGLY CAUTIONED-Some material may be inappropriate for children under 13
5.PG-R	Restricted, under 17 requires accompanying parent or adult guardian.
6.R	RESTRICTED-Under 17 requires accompanying parent or adult guardian
7.NC-17	NO ONE 17 AND UNDER ADMITTED
8. Adult	Above 17 Admitted

[6] TV TYPE:

Set TFT screen mode to the correct ratio:

Three screen ratio modes are available, Normal/PS (4:3 Pan Scan), Normal/LB (4:3 Letterbox) and Wide (16:9). Different disc formats will display different images depending this setting and the screen size used.

[7] NTSC/ PAL:

Select this menu item to set up your preferred video output format. PAL is commonly used in Europe, NTSC is commonly used in the USA and Japan.

[8] DEFAULT:

Factory reset. Set all values to Factory default values including memory and preset stations.

System information

 <p>The screenshot shows a 'SETTINGS' menu with a dark background and orange icons on the left. The text in the menu includes: 'Servo: HI6CD1-BAA-834B', 'MPEG : RD8292-046_DUST(A)_PA Ver 01.XX.X', 'Main Unit : RD6724-571 Ver 01.XX.X', 'Bluetooth : wiseblue V00.00', and 'Copyright(c) 2012 by KRS All right reserved'. The top right corner shows 'AM 10:38' and the bottom left corner shows 'SYSTEM'.</p>	<p>The software version is just for your reference. Noted: RD8292-046_DUST is only for PD-344T/PD-344BT, RD8292-046_DUSA only for PD-344/PD-344B.</p>
--	---

AV IN

Connect an optional AV cable to your external AV device (such as a video camera), then press the MODE button to switch to the AV mode. Note: If there is no external video input, the TFT displays "NO SIGNAL".

Parking

When the car is stopped and the parking brake is working, the screen can display the video image, and otherwise the screen display warning information.

Back view camera

This unit is equipped with back view camera output. The camera is used to observe the situation behind the vehicle when you are backing the car.

Please connect your back view camera with the back car video input. And connect the reverse wire for back a car with the rear gear light. Rear view camera picture will be enabled when you are backing the car.

Radio operation

Band selection

Press Band button on the RC or front panel to select your band of choice in the following sequence:



Manual tuning

To find a station, select a band first, then press and hold ◀◀ / ▶▶ buttons on the RC until Manual appear on the display. Then press repeatedly these buttons to search for the needed frequency upward or downward.

Auto tuning

To find a station, select a band first, then press ◀◀ / ▶▶ buttons on the panel or press ◀◀ / ▶▶ buttons on the RC, the automatic search will start downward or upward. It will stop when a station is found.

Select a station

Repeatedly press ◀◀ / ▶▶ buttons on the panel to select a present station downward or upward. Or press digital number (1-6) on the RC to select any present station.

Preset scan

In tuner mode, press the AS/PS on the panel or RPT/P.SCN button on the remote to scan the preset memorized station, each preset scan for 5 seconds. Press again to stop operation.

Auto store

In tuner mode, Press the AS/PS on the panel or or RPT/P.SCN button on the RC and hold for 2 seconds to store radio stations with the best reception to the preset number automatically.

Manual store

In tuner mode, long press the number 1-6 buttons on the RC after you find the station you desired. The station will preset to the corresponding number.

In tuner mode, long press the MEM button on the front panel after you find the station you desired, then rotate the VOL knob to select the number 1-6 on the radio interface, press the VOL/OK button on the front panel to confirm. The station will preset to the corresponding number.

Stereo/Mono

In FM band, press Stereo/Mono button on the RC to select stereo or mono sound reception.

DVD/USB/SD/MMC Operation

Load DISC

1. Turn the power on.
2. Press the Open button on the front panel to flip it down.
3. Insert the disc with the printed side facing upward into the slot and then attach the front panel. The DVD mode will be turned automatically.
4. Press Open button on the panel and Eject button in the inner panel to eject the disc. If the disc not removed for about 10 seconds after eject, the disc will reinserted automatically. When disc in/out, put the front at 0 degree to avoid distorting the disc.
- 5 You may also choose the playing mode using the Mode button.

NOTE:

The back view camera is available when the DVD mode is working.

USB Flash Memory

To play MP3/ MP4/ WMA files from a USB flash memory, insert a USB/iPod flash memory into the USB port on the right side of the unit. The unit will play automatically MP3/MP4/ WMA/JPEG files. Or repeatedly press the MODE button to select USB mode.

SD/MMC Card

To play MP3/ MP4/ WMA/JPEG files on a SD/MMC card, insert the card into the card slot (you should press the Open button on the panel to flip down front panel and insert the SD/MMC card into card slot.) The unit will play automatically MP3/MP4/ WMA/JPEG files. Or repeatedly press the MODE button to select SD mode.

Play/Pause

In Multimedia mode, press Play/Pause button on the RC or front panel to pause playback. Press again to resume playback.

Stop playback

In Mp3 mode press Stop button on the RC to stop playback. Press Play/pause button to restart playback. In DVD mode press Stop button once on the RC to pause playback. Press again to resume playback. Press the Stop button twice to finally stop playback. Press the Play/Pause button to restart playback.

Select track

Press the M.SEL button on the front panel or RC to select the playback mode: MUSIC MODE→ PHOTO MODE→ VIDEO MODE. Then press the UP/DOWN button on the RC, also you can rotate the VOL knob or press the ◀◀ or ▶▶ on the front panel to select the file you desired to



playback. Press ENTER button on the front panel or RC to enter the next menu, press the MENU button on the front panel to turn to previous menu. Press the MENU button on the RC to back to main menu.

During playback press SEEK- ◀◀ or SEEK+ ▶▶ on the RC or front panel to play the previous or next track. You can play the tracks by pressing Play/Pause button. Press number button (0-9) on the RC to select the desired track and then press ENTER button on the RC to confirm playback.

Fast forward/rewind

During playback press and hold repeatedly SEEK- ◀◀ or SEEK+ ▶▶ on the RC or the panel to activate fast backward or forward playing. With each pressing, the playback speed will increase. While fast playback, press Play/Pause button on the RC to resume normal speed. When fast backward/forward playback reaches the previous or next track, the unit will resume normal playback.

A-B segment repeat

During playback, press it at the starting point of section you want to repeat (A), press this button again at the ending point of the section you want to repeat (B), section A-B repeating starts. Press it again to cancel the A-B repeat function.

Random playback

In Media file mode, press RDM button on the RC to set shuffle playback on or off.

Introduce playback

In CD mode, Press INT button on the RC to activate introduction function. Several initial seconds of each track will be played. Press the button again to cancel intro playback.

GOTO

During playback, press and hold AUIO/GOTO button on the RC to select playback track or chapter. Then a time search message box will display on the screen. Input the start time you want the track or chapter to start. Press ENTER to confirm. The track or chapter will start from the time you set.

Repeat playback

During playback, press P.SCAN/RPT button on the RC or front panel repeatedly for repeat playing in different modes: Repeat one, repeat track, and repeat all, repeat chapter, repeat title, repeat off.

PROG playback

Press PROG button on the RC to enter program list.

Press ◀/▶/▲/▼ buttons and digit buttons to enter the number of the desired track to be on selected position. For DVD and file disc, select title and chapter number; For VCD and CD, select track number.

Move the cursor to select START and press ENTER button on the RC to play.

If you want to change page, move the cursor to NEXT ▶▶ for PREV ◀◀ and press ENTER button on the RC to change next or previous page.

If you want to cancel PROG playback, press again PROG button on the RC and then select Stop option to stop PROG playback.

OSD function

During playback, press repeatedly to show display information. Such as: Number of title, number of chapter, TITLE elapsed => TITLE remain => CHAPTER elapsed => CHAPTER remain =>Display off.



Zoom in/out

Press it and hold for two seconds in Movie mode to zoom the image in or out in the sequence of 2x-> 3x-> 4x-> 1/2-> 1/3-> 1/4->normal.

PBC function

During VCD disc playback, press and hold STOP/PBC button on the RC to set PBC on or off; When PBC is on, the screen will show PBC menu. If the menu consists of a list of titles, you can select a desired one using number buttons on the RC.

Changing angle

Press it repeatedly to change the viewing angle (Available only with a recorded DVD file or DVD disc that support multi-angle playback)

Select audio language

During DVD disc playback, press AUDIO/GOTO button on the RC repeatedly to select the audio language to listen. (Available only with a recorded DVD file or DVD disc that support multi-language playback).

Select subtitle language

If your DVD disc supports multi-language subtitle, press SUB-T button on the RC repeatedly to switch among disc-supported language.

Select sound channel

During VCD disc playback press AUDIO/GOTO button on the RC to select the sound channel: L-MONO=>R-MONO=>MIX-MONO=>Stereo.

Dual function(if you need)

DUAL KEY setting: Short press to switch DUAL function on/off. During Dual operation, long press it switch C-DUAL and D-DUAL.

Activating Dual Zone Mode

- Access GENERAL setup in the SETTINGS menu and find DUAL mode and select ON.
- Insert a DVD or begin playing a movie from SD card or USB.

Controlling the Front Zone (C-DUAL)

- Press DUAL button on the RC, C-DUAL appears on the screen.
- Press the MENU button on the RC or front panel to return to the main menu. Select the mode you wish to use in the front zone.
- The units screen will change to the selected mode. The DVD or SD/USB movie will continue to play only on the AV outputs, while the selected mode audio is played through the front and rear LINE outputs. All front panel and remote controls will affect only the selected mode activated for the front zone.

Controlling the Rear Zone (D-DUAL)

- During C-DUAL mode, press and hold the DUAL button on the RC until D-DUAL appears on the screen.
- All front panel and remote control functions for DVD, USB, or SD, including volume, will control only the media playing for the rear zone.

TV Operations(Only for PD-344T /PD-344BTmodel)

1. Connect TV antenna, and then press MODE button to select TV mode.
2. In TV mode, press the Play/pause button once to enter TV menu setting.
3. Press the / buttons on the remote control or turning the knob clockwise or counterclockwise on front panel to select one of the setup pages: Auto program => Manual program.
4. Press VOL button on front panel or ENTER button on remote control to enter the page.
5. Press the / buttons to select the setting.
6. Press VOL button on front panel or ENTER button on remote control again to confirm, press Play/pause to return to settings list.

TV MENU

Press the MEM button to enter the setup menu of TV.

Auto program (Auto seek mode)

● System

Select the menu item is to set TV system: NTSC=>PAL=>SECAM, press ENTER button on remote.

● Audio

Select this menu item is to set the TV sound system:

- 1) When system setting PAL, TV sound system can set B/G=>I=>D/K=>/M/N, press ENTER on remote.
- 2) When system setting SECAM, TV sound system can set B/G=>I=>D/K, press ENTER on remote.
- 3) When system setting NTSC, M/N sound system can be selected only.

● Search

Select this menu item is to start searching and storing stations automatically.

Manual program (manual seek mode)

Storage

Select this menu item is to set the storage number.

● System

Select this menu item is to set TV system: SECAM => NTSC =>PAL, press ENTER button on the remote control to select.

● Audio

Select this menu item is to set the TV sound system:

- 1) When system settings PAL, press ENTER on remote or tap the screen button to select TV sound system: D/K=>M/N=> B/G=> I.
- 2) When system setting SECAM, TV sound system B/G=>I=>D/K.
- 3) When system setting NTSC, M/N sound system can be selected only.

Channel

Select this menu item is to set your desired searching channel, press / button on the RC to select one, or press / icon to select channel.

● Fine

Select this menu item is to fine TV tuning and sound until it achieves the best quality, press / button on remote to adjust.

● Memory

Select memory on or off is to set whether memory the searched station or not, press ENTER on remote control to select.

Bluetooth Section(Only for PD-344B/PD-344BTmodel)

Warning: Driving and having a Telephone conversation at the same time is dangerous, please park your car before having a telephone conversation. The supplier assumes any and all liability when this warning is not followed.

To enter Bluetooth mode, you can press mode button on remote or on front panel.

BT Main Menu



Bluetooth disconnect mode



Bluetooth connect mode

A user can make own choice by press $\blacktriangleleft / \blacktriangleright$ on the panel or $\blacktriangleleft / \blacktriangleright / \blacktriangleup / \blacktriangledown$ on the RC to select the icons as below.

Select CALLING icon to use phone functions.

Select MUSIC icon to start BLUETOOTH music player.

Select DAILED icon to display the phone number dialed out.

Select RECEIVED icon to display the phone number received.

Select MISSED icon to display the phone number missed.

Tap PHONEBOOK icon to use phone book functions.

Pairing Mode

At the 1st time when using BLUETOOTH, you need to pair the mobile phone first.

When a phone have not been paired with the unit, the BT icon and Pairing mark will blink continually on the panel.

When the unit have connect with phone, the BT icon will turn on and the Mobile phone name (if available) will be display on the panel.

According to mobile pairing device manual, after searching new device (Soundstream), select it, input password "0000" and confirm ok, device paring is finished.

The text 'Enter Number' will shows on the panel after the pairing is completed. It means device is connected and ready for BLUETOOTH communication.



Auto-connect - Disconnect

When power on the unit, the last paired phone will be connected to the device via Bluetooth automatically, after searching about one minute, if the device cannot find the paired phone, it will stop searching. When in standby mode (unconnected), long press Bluetooth button on remote control to active auto-connect function and the device will search the last paired phone.

If you want to disconnect the Bluetooth connection, just turn off the Bluetooth on the phone.

1.CALLING

press $\blacktriangleleft / \blacktriangleright$ on the panel or $\blacktriangleleft / \blacktriangleright / \blacktriangleup / \blacktriangledown$ on the RC to select CALLING icon and press VOL button on panel or enter button on the RC to confirm the selection to enter call mode.

In Call mode, the unit can be used as your phone. Making and receiving calls are possible with BLUETOOTH. Simply press phone number on the RC and press  button to make a call, and press  button to hang up.

NOTE: the phonebook only supports Western Characters. Any difference in character will be shown such as “ + , * or # ”.

2. (A2DP) Music Model

press **⏮ / ⏭** on the panel or **⏮/⏭/⏸/⏹** on the RC to select MUSIC icon and press VOL button on panel or enter button on the RC to confirm the selection to listen music in Bluetooth mode.

You can select the function with the key for previous, play / pause, stop, and next.

A2DP (Advanced Audio Distribution Profile) Music Player

A2DP is a function which can receive the audio frequency signal from the mobile phone, amplified by the car audio and played out by the car speakers.

Notice: your mobile phone need to support A2DP.

press corresponding buttons (PAUSE/PLAY, STOP, PREVIOUS/NEXT) on remote control to play, pause, play previous, or next music file.



3. DAILED

press **⏮ / ⏭** on the panel or **⏮/⏭/⏸/⏹** on the RC to select DAILED icon and press VOL button on panel or enter button on the RC to confirm the selection to display the phone number dialed out. Rotate the VOL button on panel or **⏮/⏭/⏸/⏹** on the RC to select the number you desired ,then press VOL button on panel or enter button on the RC, the number you select will be dialed out.

4. RECEIVED

press **⏮ / ⏭** on the panel or **⏮/⏭/⏸/⏹** on the RC to select RECEIVED icon and press VOL button on panel or enter button on the RC to confirm the selection to display the phone number received. Rotate the VOL button on panel or **⏮/⏭/⏸/⏹** on the RC to select the number you desired ,then press VOL button on panel or enter button on the RC, the number you select will be dialed out.



5. MISSED

press **⏮ / ⏭** on the panel or **⏮/⏭/⏸/⏹** on the RC to select MISSED icon and press VOL button on panel or enter button on the RC to confirm the selection to display the phone number missed. Rotate the VOL button on panel or **⏮/⏭/⏸/⏹** on the RC to select the number you desired ,then press VOL button on panel or enter button on the RC, the number you select will be dialed out.



6. BT PHONE BOOK

The unit can download the data from phone automatically when the pairing between a phone and the unit is completed.

The unit displays the data which have been downloading from a phone.



Select a number and press enter button to make a calling. Press the PB-DOWN button, phonebook will be updated and downloaded with new phonebook.

Anti-theft system

Remove the panel

1. Press the PWR button to turn the power off.
2. Press OPEN button to detach the panel.
3. Pull the panel out.
4. Place the panel into the case and take it with you when you leave the car.

Remove the unit

1. Remove the panel and the trim plate.
2. Insert both T-Keys into hole on the front of the set until they lock.
3. Pull out the unit.

NOTE:

The source unit will turn off if the control panel is open longer than 60 seconds.
The LED light on the inner panel will twinkle in red when the ACC power is cut off.

Handling & Cleaning DISC

Handling

- Dirty, scratched or warped discs may cause skipping or noise.
- To keep the disc clean, only handle the disc by its edges.
- Discs should be stored in their cases after use to avoid scratches.
- Do not expose discs to direct sunlight, high humidity, high temperature or dust.
- Prolonged exposure to extreme temperature can warp the disc (such as leaving the discs in your car in summer heat).
- Do not stick or write anything on either side of disc. Sharp writing instruments, or the ink used in some felt-tip pens, may damage its surface.
- Do not touch the unlabelled side. Do not attach any seal, label or data protection sheet to either side of a disc.

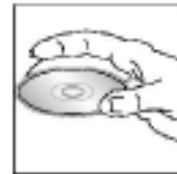

Cleaning DISC

Fingerprints should be carefully wiped from the surface of disc with a soft cloth. Unlike conventional records, compact discs have no grooves to collect dust or dirt, so gently wiping them with a soft cloth should remove most dust or stains. Wipe in a straight motion from the centre to the edge.



CAUTION: Never use thinner benzene, record cleaner or anti-static spray on a compact disc. Such chemicals can damage its plastic surface.

Troubleshooting guide

Symptom	Cause	Solution
General No power	The car ignition is not on. The fuse is blown.	If the power supply is properly connected to the car accessory switch the ignition key to "ACC". Replace the fuse.
Disc cannot be read	Inserting the disc in upside down. Compact disc is extremely dirty or defective. Temperature inside the car is too high.	Insert the compact disc with the label facing upward. Clean the disc or try to play a new one. Cool off until the ambient temperature returns to normal.
No sound	Volume is in minimum. Wiring is not properly connected.	Adjust volume to a desired level. Check wiring connection.
The operation keys do not work.	The built-in microcomputer is not operating properly due to noise. Front panel is not properly fixed into its place.	Press the RESET button. Reinstall the front panel.
Sound skips.	The installation angle is more than 30 degrees. The disc is extremely dirty or defective.	Adjust the installation angle to less than 30 degrees. Clean the compact disc/try to play a new one.
The radio does not work; the radio station automatic selection does not work.	The antenna cable is not connected the signals are too weak.	Insert the antenna cable firmly select a station manually.

Specification

General	
Power supply:	12 V DC
Current consumption:	Max. 10 A
Maximum power output:	52W x 4 channels (Max.)
Compatible formats:	DVD/SVCD/VCD/HDCD/MP3/MP4/WMA/CDDA/Picture-C D/JPEG/CD-R/ -RW/DVD±R/±RW playback
Dimensions (W x D x H) / weight:	178 x 175 x 50 mm / 1.8 kg
ESP function:	40 sec. for Audio CD, 120 sec. for MP3
Working temperature range:	-10°C - +60°C
TFT display	
Screen size:	3.4 inch
Resolution:	720*400 dot
Aspect ratio:	4:3/16:9
Contrast ratio:	400:1
Brightness:	250 cd/m2
FM Stereo Radio	
Frequency range(U.S.A AREA)	87.5 – 107.9MHz(Step 200KHz)
Frequency range(EUROPE AREA):	87.5 – 108MHz(Step 50KHz)
Frequency range(SOUTH AMERICA AREA)	87.5 – 108MHz(Step 100MHz)
Frequency range(RUSSIA AREA)	87.5 – 108MHz(Step 50KHz) 65-74MHz(Step 10KHz)
Preset memory stations:	18
AM/MW Radio	
Frequency range(U.S.A AREA)	530kHz - 1710 KHz(Step 10KHz)
Frequency range(EUROPE AREA):	522kHz - 1620 KHz(Step 9KHz)
Frequency range(SOUTH AMERICA AREA)	520kHz - 1710 KHz(Step 10KHz)
Frequency range(RUSSIA AREA)	522kHz - 1620 KHz(Step 9KHz)
Preset memory stations:	12
Audio specification	
Maximum output:	2Vrms (+/- 3 dB)
Frequency response:	20 Hz - 20 KHz
S/N ratio(A-vtd):	68 dB
DSP sound effect:	EQ FLAT→EQ CLASSIC→EQ POP→EQ ROCK→EQ OFF
Line out	
Line outs:	4 channel RCA line-out
Video Output	Video Output Impedance: 75Ω Video Output Level: 1.0±0.2V (under normal video input level)

Specifications are subject to change without notice. Mass and dimension are approximate.