

Operating Instructions DVD Home Theater Sound System

Model No. **SC-PT480**

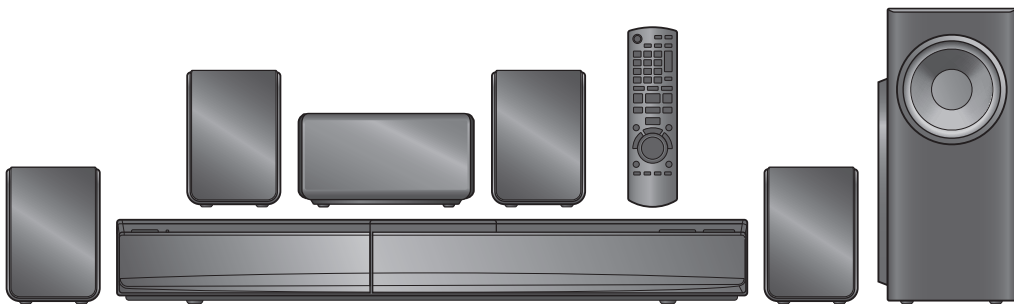

Dear customer

Thank you for purchasing this product. For optimum performance and safety, please read these instructions carefully.

**Before connecting, operating or adjusting this product, please read the instructions completely.
Please keep this manual for future reference.**

The illustrations shown may differ from your unit.

Region number

The player plays DVD-Video marked with labels containing the region number "1" or "ALL".

Example:



As an ENERGY STAR® Partner,*
Panasonic has determined that
this product meets the ENERGY STAR®
guidelines for energy efficiency.

* For Canada only: The word "Participant" is used in place of the word "Partner".

If you have any questions contact

U.S.A. and Puerto Rico : 1-800-211-PANA (7262)

Canada : 1-800-561-5505

Only for U.S.A. and Puerto Rico :

The warranty can be found on page 24.

Only for Canada :The warranty can be found on page 25.



- Please note that the actual controls and components, menu items, etc. of your DVD Home Theater Sound System may look somewhat different from those shown in the illustrations in these Operating Instructions.
- Operations in these instructions are described mainly with the remote control, but you can perform the operations on the main unit if the controls are the same.

System		SC-PT480
Main unit		SA-PT480
Speaker system	Front speakers	SB-HF480
	Center speaker	SB-HC480
	Surround speakers	SB-HS480
Subwoofer		SB-HW480

Accessories



Please check and identify the supplied accessories. Use numbers indicated in parentheses when asking for replacement parts. (Product numbers correct as of November 2009. These may be subject to change.)

Only for U.S.A. and Puerto Rico:

To order accessories, refer to "Accessory Purchases (United States and Puerto Rico)" on page 24.

For other areas: To order accessories, call the dealer from whom you made your purchase.

- | | |
|---|---|
| <input type="checkbox"/> 1 Remote control (N2QAYB000514) | <input type="checkbox"/> 5 Speaker cables [REEX1152A (red), REEX1153A (white), REEX1154 (green), REEX1155 (gray), REEX1156 (blue)] |
| <input type="checkbox"/> 2 Remote control batteries | <input type="checkbox"/> 1 AC power supply cord (K2CB2CB00021) |
| <input type="checkbox"/> 1 FM indoor antenna (RSAX00002) | <input type="checkbox"/> 1 Sheet of speaker cable stickers |
| <input type="checkbox"/> 1 Video cable (K2KA2BA00001) | |

CAUTION!

THIS PRODUCT UTILIZES A LASER. USE OF CONTROLS OR ADJUSTMENTS OR PERFORMANCE OF PROCEDURES OTHER THAN THOSE SPECIFIED HEREIN MAY RESULT IN HAZARDOUS RADIATION EXPOSURE. DO NOT OPEN COVERS AND DO NOT REPAIR YOURSELF. REFER SERVICING TO QUALIFIED PERSONNEL.

The socket outlet shall be installed near the equipment and easily accessible.

The mains plug of the power supply cord shall remain readily operable. To completely disconnect this apparatus from the AC Mains, disconnect the power supply cord plug from AC receptacle.

THE FOLLOWING APPLIES ONLY IN THE U.S.A.

WARNING:

TO REDUCE THE RISK OF FIRE, ELECTRIC SHOCK OR PRODUCT DAMAGE,

- **DO NOT EXPOSE THIS APPARATUS TO RAIN, MOISTURE, DRIPPING OR SPLASHING AND THAT NO OBJECTS FILLED WITH LIQUIDS, SUCH AS VASES, SHALL BE PLACED ON THE APPARATUS.**
- **USE ONLY THE RECOMMENDED ACCESSORIES.**
- **DO NOT REMOVE THE COVER (OR BACK); THERE ARE NO USER SERVICEABLE PARTS INSIDE. REFER SERVICING TO QUALIFIED SERVICE PERSONNEL.**

FCC Note:

This equipment has been tested and found to comply with the limits for a Class B digital device, pursuant to Part 15 of the FCC Rules. These limits are designed to provide reasonable protection against harmful interference in a residential installation. This equipment generates, uses and can radiate radio frequency energy and, if not installed and used in accordance with the instructions, may cause harmful interference to radio communications. However, there is no guarantee that interference will not occur in a particular installation. If this equipment does cause harmful interference to radio or television reception, which can be determined by turning the equipment off and on, the user is encouraged to try to correct the interference by one or more of the following measures:

- Reorient or relocate the receiving antenna.
- Increase the separation between the equipment and receiver.
- Connect the equipment into an outlet on a circuit different from that to which the receiver is connected.
- Consult the dealer or an experienced radio/TV technician for help.

Any unauthorized changes or modifications to this equipment would void the user's authority to operate this device.

This device complies with Part 15 of the FCC Rules. Operation is subject to the following two conditions: (1) This device may not cause harmful interference, and (2) this device must accept any interference received, including interference that may cause undesired operation.

Responsible Party:
Panasonic Corporation of North America
One Panasonic Way
Secaucus, NJ 07094

Support Contact:
Panasonic Consumer Electronics Company
Telephone No.: 1-800-211-PANA(7262)

CAUTION!

DO NOT INSTALL OR PLACE THIS UNIT IN A BOOKCASE, BUILT-IN CABINET OR IN ANOTHER CONFINED SPACE. ENSURE THE UNIT IS WELL VENTILATED. TO PREVENT RISK OF ELECTRIC SHOCK OR FIRE HAZARD DUE TO OVERHEATING, ENSURE THAT CURTAINS AND ANY OTHER MATERIALS DO NOT OBSTRUCT THE VENTILATION VENTS.



CAUTION
RISK OF ELECTRIC SHOCK
DO NOT OPEN



CAUTION: TO REDUCE THE RISK OF ELECTRIC SHOCK, DO NOT REMOVE SCREWS. NO USER-SERVICEABLE PARTS INSIDE. REFER SERVICING TO QUALIFIED SERVICE PERSONNEL.



The lightning flash with arrowhead symbol, within an equilateral triangle, is intended to alert the user to the presence of uninsulated "dangerous voltage" within the product's enclosure that may be of sufficient magnitude to constitute a risk of electric shock to persons.



The exclamation point within an equilateral triangle is intended to alert the user to the presence of important operating and maintenance (servicing) instructions in the literature accompanying the appliance.

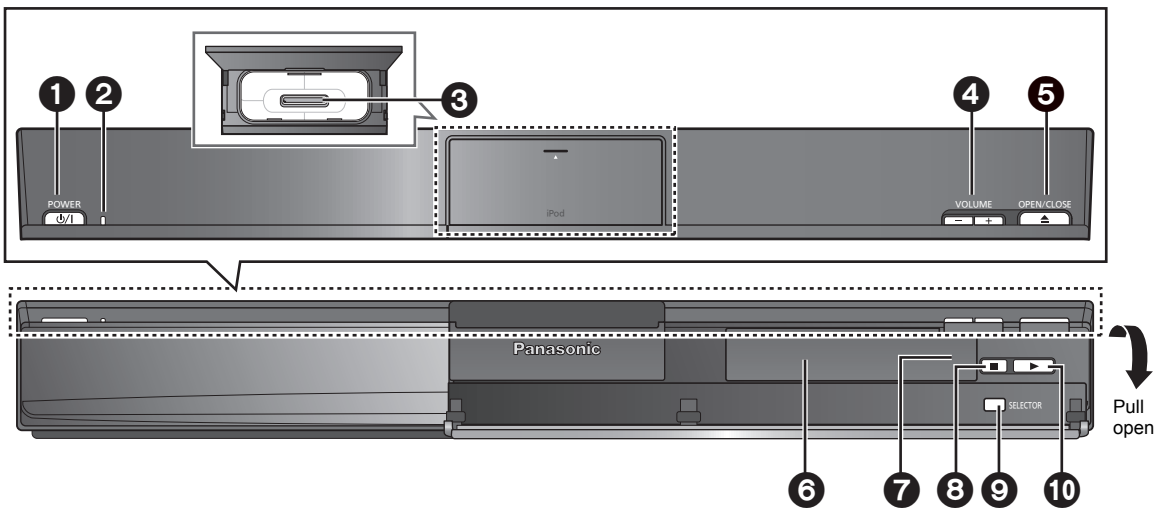
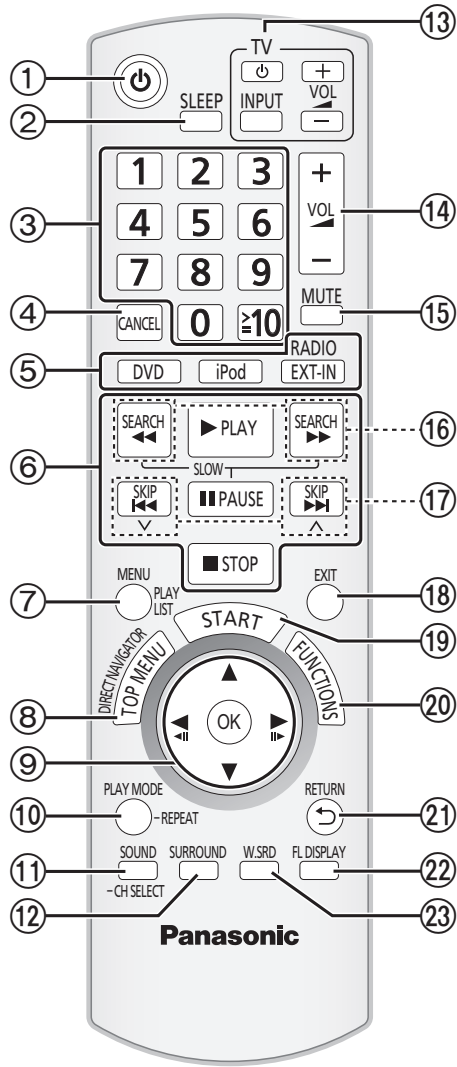

Note

The circled numbers indicated in the operating instructions (e.g. Press [⏻]①) correspond to the circled numbers in the above.

Control reference guide

Remote control

- ① Turn the main unit on/off (⇒ 8)
- ② **Set the Sleep timer**
Press [SLEEP].
SLEEP 30 → SLEEP 60 → SLEEP 90 → SLEEP120
↑ OFF (Cancel) ↓
 - To confirm the remaining time, press the button again.
- ③ Select channels and title numbers etc. / Enter numbers (⇒ 8, 11)
- ④ Cancel (⇒ 11)
- ⑤ **Source select**
[DVD]: Select disc as the source (⇒ 11)
[iPod]: Select iPod as the source (⇒ 15)
[RADIO, EXT-IN]: Select the FM tuner or the external audio source. (⇒ 8, 9)
FM → AUX → ARC → D-IN
↑ ↓
- ⑥ Basic operations for play (⇒ 11)
- ⑦ Show a disc menu or play list (⇒ 11, 12)
- ⑧ Show a disc top menu or program list (⇒ 11, 12)
- ⑨ Select or confirm menu items / Frame-by-frame (⇒ 11)
- ⑩ Select the play mode / Set the repeat mode (⇒ 11)
- ⑪ Select sound mode / Adjust speaker level (⇒ 10)
- ⑫ Select surround sound effects (⇒ 10)
- ⑬ **TV operations**
Aim the remote control at the Panasonic TV and press the button.
[⏻]: Turn the TV on/off
[INPUT]: Change the TV's video input mode
[+, VOL, -]: Adjust the TV volume
This may not work properly with some models.
- ⑭ Adjust the volume of the main unit
- ⑮ **Mute the sound**
 - "MUTE" flashes on the main unit's display while the function is on.
 - To cancel, press the button again or adjust the volume.
 - Muting is cancelled when you switch the unit to standby.
- ⑯ Select radio stations manually (⇒ 8)
- ⑰ Select preset radio stations (⇒ 8)
- ⑱ Exit the display
- ⑲ Show START menu (⇒ 9)
- ⑳ Show on-screen menu (⇒ 12)
- ㉑ Return to previous screen (⇒ 11)
- ㉒ Switch information on the main unit's display (⇒ 11)
- ㉓ Turn Whisper-mode Surround on/off (⇒ 10)

Avoiding interference with other Panasonic equipment

Other Panasonic audio/video equipment may start functioning when you operate the unit using the supplied remote control. You can operate this unit in another mode by setting the remote control operating mode to "REMOTE 2".

The main unit and remote control must be set to the same mode.

- 1 Press [RADIO, EXT-IN] to select "AUX".
- 2 Press and hold [▶] on the main unit and [2] on the remote control until the main unit's display shows "REMOTE 2".
- 3 Press and hold [OK] and [2] on the remote control for at least 2 seconds.

To change the mode back to "REMOTE 1", repeat the steps above by replacing [2] with [1].

Main unit

- ① **Standby/on switch (POWER ⏻/⏻)**
Press to switch the unit from on to standby mode or vice versa. In standby mode, the unit is still consuming a small amount of power.
- ② Power indicator
The indicator lights when this unit is turned on.
- ③ Connect iPod (⇒ 15)
- ④ Adjust the volume of the main unit
- ⑤ Open/Close the disc tray (⇒ 11)
- ⑥ Display
 - "SRD" lights when sound is output to the surround speakers. (⇒ 10)
 - The display is turned off when the volume is adjusted to "0". (⇒ 17)
- ⑦ Remote control signal sensor
- ⑧ Stop playing
- ⑨ Select the source
DVD/CD → FM → AUX → ARC → D-IN → IPOD
↑ ↓
- ⑩ Play disc

Saving energy

This unit is designed to conserve its power consumption and save energy.

- This unit will automatically turn to standby mode after 30 minutes if it is inactive.

TABLE OF CONTENTS

Getting Started

Accessories	2
Control reference guide	4
IMPORTANT SAFETY INSTRUCTIONS	below

Quick Start Guide

step 1 Positioning	6
step 2 Connections	6
Speaker connections	6
Radio antenna connections	6
Audio and video connections	7
step 3 AC power supply cord connection	7
step 4 Preparing the remote control	7
step 5 EASY SETUP	8

Listening to the radio	8
Presetting stations automatically	8
Listening/confirming the preset channels	8
Manual tuning	8
Using the START menu	9
Selecting the source by the remote control	9
Listening to the TV or other device's audio from this unit's speakers	9

Enjoying sound effects from all speakers

Enjoying surround sound effects	10
Selecting sound mode	10
Whisper-mode Surround	10
Adjusting the speaker output level manually	10
Adjusting the speaker level during playback	10

Playing Discs

Basic play	11
Other modes of play	11
Repeat play	11
Program and Random play	11
Using navigation menus	12
Playing data discs	12
Playing DVD-R/-RW (DVD-VR) discs	12
Using on-screen menus	12

Other Operations

Using the VIERA Link™ “HDAVI Control™”	14
What is VIERA Link “HDAVI Control”	14
What you can do with “HDAVI Control”	14
Easy control only with VIERA remote control (for “HDAVI Control 2 or later”)	15
Using the iPod	15

Reference

Changing the player settings	16
Discs that can be played	18
Maintenance	18
Speaker installation option	19
Troubleshooting guide	20
Specifications	22
Licenses	23
Product Service	23
Limited Warranty (ONLY FOR U.S.A. AND PUERTO RICO)	24
Limited Warranty (ONLY FOR CANADA)	25

IMPORTANT SAFETY INSTRUCTIONS

Read these operating instructions carefully before using the unit. Follow the safety instructions on the unit and the applicable safety instructions listed below. Keep these operating instructions handy for future reference.

- 1) Read these instructions.
- 2) Keep these instructions.
- 3) Heed all warnings.
- 4) Follow all instructions.
- 5) Do not use this apparatus near water.
- 6) Clean only with dry cloth.
- 7) Do not block any ventilation openings. Install in accordance with the manufacturer's instructions.
- 8) Do not install near any heat sources such as radiators, heat registers, stoves, or other apparatus (including amplifiers) that produce heat.
- 9) Do not defeat the safety purpose of the polarized or grounding-type plug. A polarized plug has two blades with one wider than the other. A grounding-type plug has two blades and a third grounding prong. The wide blade or the third prong are provided for your safety. If the provided plug does not fit into your outlet, consult an electrician for replacement of the obsolete outlet.
- 10) Protect the power cord from being walked on or pinched particularly at plugs, convenience receptacles, and the point where they exit from the apparatus.
- 11) Only use attachments/accessories specified by the manufacturer.
- 12) Use only with the cart, stand, tripod, bracket, or table specified by the manufacturer, or sold with the apparatus. When a cart is used, use caution when moving the cart/apparatus combination to avoid injury from tip-over.
- 13) Unplug this apparatus during lightning storms or when unused for long periods of time.
- 14) Refer all servicing to qualified service personnel. Servicing is required when the apparatus has been damaged in any way, such as power-supply cord or plug is damaged, liquid has been spilled or objects have fallen into the apparatus, the apparatus has been exposed to rain or moisture, does not operate normally, or has been dropped.



Getting Started
Playing Discs
Other Operations
Reference

step 1 | Positioning

How you set up your speakers can affect the bass and the sound field. Note the following points:

- Place speakers on flat secure bases.
- Placing speakers too close to floors, walls, and corners can result in excessive bass. Cover walls and windows with thick curtains.
- For optional wall mount, refer to page 19.

Note

Keep your speakers at least 10 mm ($13/32''$) away from the system for proper ventilation.

Setup example ("Surround layout (Recommended)"): Standard surround placement

Place the front, center, and surround speakers at approximately the same distance from the seating position. The angles in the diagram are approximate.

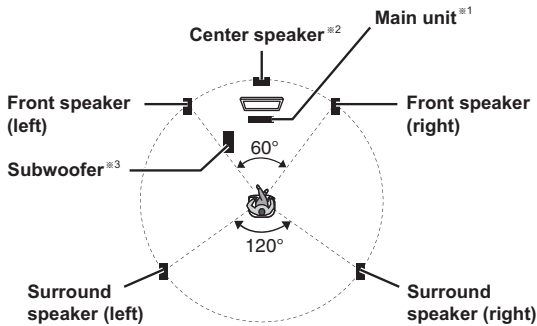

- ※1 Position with at least 5 cm (2") of space on all sides for proper ventilation.
- ※2 Put on a rack or shelf. Vibration caused by the speaker can disrupt the picture if it is placed directly on the TV.
- ※3 Place to the right or left of the TV, on the floor or a sturdy shelf so that it will not cause vibration. Leave about 30 cm ($11^{13}/16''$) from the TV.

Depending on the room layout, you may like to use all the speakers at the front ("Front layout (Alternative)") (⇒ 8, Easy setup settings).

Notes on speaker use

Use only supplied speakers

- Using other speakers can damage the unit, and sound quality will be negatively affected.
- You can damage your speakers and shorten their useful life if you play sound at high levels over extended periods.
- Reduce the volume in the following cases to avoid damage:
 - When playing distorted sound.
 - When the speakers are reverberating due to a record player, noise from FM broadcasts, or continuous signals from an oscillator, test disc, or electronic instrument.
 - When adjusting the sound quality.
 - When turning the unit on or off.

If irregular coloring occurs on your TV

The center speaker is designed to be used close to a TV, but the picture may be affected with some TVs and setup combinations.

If this occurs, turn the TV off for about 30 minutes.

The demagnetizing function of the TV should correct the problem. If it persists, move the speakers further away from the TV.



Caution

- The main unit and supplied speakers are to be used only as indicated in this setup. Failure to do so may lead to damage to the amplifier and/or the speakers, and may result in the risk of fire. Consult a qualified service person if damage has occurred or if you experience a sudden change in performance.
- Do not attempt to attach these speakers to walls using methods other than those described in this manual.

Caution

Do not touch the front netted area of the speakers. Hold by the sides.

step 2 | Connections

Turn off all equipment before connection and read the appropriate operating instructions.

Do not connect the AC power supply cord until all other connections are completed.

1 Speaker connections

Pay attention to the type of speaker and the connector color when you place the speakers.

Main unit (rear)

Connect to the terminals of the same color.

Use of the speaker cable stickers is convenient when making cable connections.

Speakers (rear)

Insert the wire fully, taking care not to insert beyond the wire insulation.

+ : White
– : Blue line

- Be careful not to cross (short circuit) or reverse the polarity of the speaker wires as doing so may damage the speakers.

2 Radio antenna connections

Using an indoor antenna

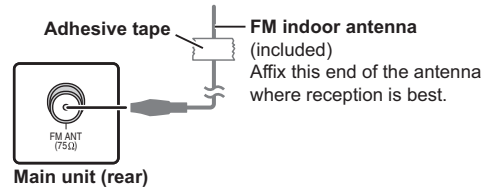

Using an outdoor antenna

Use outdoor antenna if radio reception is poor.

- Disconnect the antenna when the unit is not in use.
- Do not use the outdoor antenna during an electrical storm.

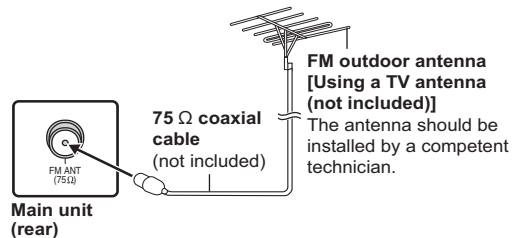

3 Audio and video connections

Basic setup example

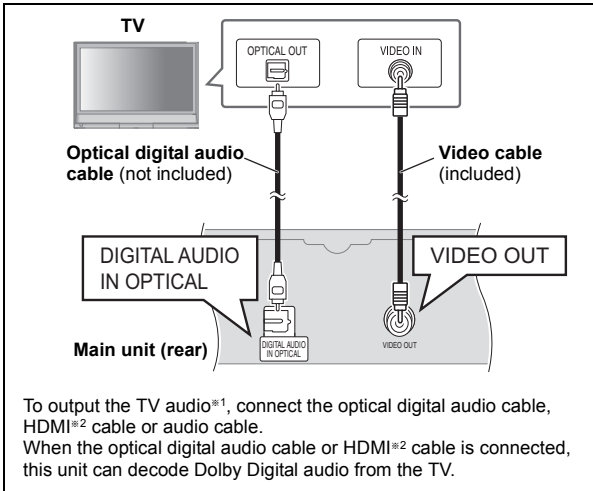

Note
After connecting with the optical digital audio cable or HDMI^{※2} cable, make settings to suit the type of audio from your digital equipment (⇒ 9).

- ※1 Refer to the operating instructions of the respective devices for the settings necessary to output the audio.
- ※2 Only when connecting to a ARC compatible TV. Refer to "Alternative video connection" for details. (⇒ below)

Alternative video connection

HDMI AV OUT

This connection provides the best picture quality.

Connect the HDMI cable (not included) from the HDMI AV OUT terminal on the main unit to the HDMI AV IN terminal on your TV.

- If your TV is not ARC compatible, make the extra audio connection.
- Set "VIDEO PRIORITY" to "ON" (⇒ 17, HDMI menu).
- Set "VIDEO FORMAT" in Menu 4 (HDMI) (⇒ 13).

VIERA Link "HDAVI Control"

If your Panasonic TV is VIERA Link compatible, you can operate your TV synchronizing with home theater operations or vice versa (⇒ 14, Using the VIERA Link™ "HDAVI Control™").

ARC (Audio Return Channel)

If the TV is ARC compatible, audio from the TV can be sent to this unit via the HDMI cable without the need to make an extra audio connection.

- Refer to the operating instructions of the TV for details.

Note

- Please use High Speed HDMI Cables that have the HDMI logo (as shown on the cover).
- Non-HDMI-compliant cables cannot be utilized.
- It is recommended that you use Panasonic's HDMI cable.
Recommended part number:
RP-CDHS15 (1.5 m/4.9 ft), RP-CDHS30 (3.0 m/9.8 ft), RP-CDHS50 (5.0 m/16.4 ft), etc.

Do not make the video connections through the VCR.

Due to copy guard protection, the picture may not be displayed properly.

Alternative audio connection

AUX

Use this connection when the TV does not have an OPTICAL OUT terminal or when the DIGITAL AUDIO IN OPTICAL terminal on this unit is being used by the STB.

Connect the audio cable (not included) from the AUX terminal on the main unit to the AUDIO OUT terminal on your TV.

Set Top Box (cable/satellite/Blu-ray Disc Player, etc) connection

Use this connection when you want to output the original surround audio from your STB, etc. to this unit.

Connect the optical digital audio cable (not included) from the DIGITAL AUDIO IN OPTICAL terminal on the main unit to the OPTICAL OUT terminal on your STB.

- If the DIGITAL AUDIO IN OPTICAL terminal is already in use for the TV audio, reconnect the TV audio to the AUX terminal using an audio cable.

Note

If you have various sound sources (such as Blu-ray player, DVD recorder, VCR, etc.), connect them to the available inputs on the TV and the TV output should then be connected to the AUX, HDMI AV OUT^{※2} or DIGITAL AUDIO IN OPTICAL terminal of the main unit.

step 3 AC power supply cord connection

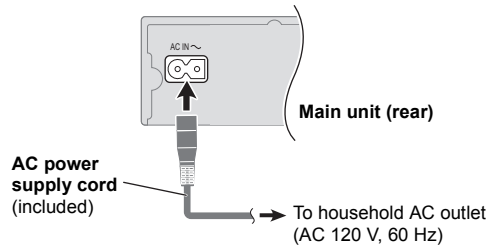

Conserving power

The main unit consumes a small amount of power, even when it is in standby mode (approx. 0.2 W). To save power when the unit is not to be used for a long time, unplug it from the household AC outlet. You will need to reset some memory items after plugging in the main unit.

Note

The included AC power supply cord is for use with the main unit only. Do not use it with other equipment. Also, do not use cords for other equipment with the main unit.

step 4 Preparing the remote control

Batteries

- 2 Insert so the poles (+ and -) match those in the remote control.

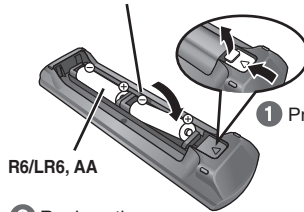

- 3 Replace the cover.

CAUTION

Danger of explosion if battery is incorrectly replaced. Replace only with the same or equivalent type recommended by the manufacturer. Dispose of used batteries according to the manufacturer's instructions.

- Use alkaline or manganese batteries.
- Do not heat or expose to flame.
- Do not leave the battery(ies) in an automobile exposed to direct sunlight for a long period of time with doors and windows closed.

Do not:

- mix old and new batteries.
- use different types of batteries at the same time.
- take apart or short circuit.
- attempt to recharge alkaline or manganese batteries.
- use batteries if the covering has been peeled off.

Mishandling of batteries can cause electrolyte leakage which can severely damage the remote control.

Remove the batteries if the remote control is not going to be used for a long period of time. Store in a cool, dark place.

Use

Aim at the remote control signal sensor (⇒ 4), avoiding obstacles.

Distance: Within approx. 7 m (23 ft)

Angle: Within approx. 20° up and down, approx. 30° to the left and right

The Easy setup screen assists you in making necessary settings.

Preparation

Turn on your TV and select the appropriate video input mode (e.g. VIDEO 1, AV 1, HDMI, etc.) to suit the connection to this unit.

- To change your TV's video input mode, refer to its operating instructions.
- This remote control can perform some basic TV operations (⇒ 4).

- 1 Press [POWER] ① to turn on the unit.
 - When the Easy setup screen appears automatically, skip steps 2 to 7.
- 2 Press [DVD] ⑤ to select "DVD/CD".
- 3 Press [START] ⑱ to show the START menu.
- 4 Press [▲, ▼] ⑨ to select "Setup" and press [OK] ⑩.

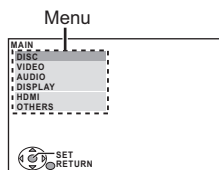

- 5 Press [▲, ▼] ⑨ to select "OTHERS" and press [OK] ⑩.
- 6 Press [▲, ▼] ⑨ to select "EASY SETUP" and press [OK] ⑩.
- 7 Press [OK] ⑩ to select "SET".
- 8 Press [▲, ▼] ⑨ to select "Yes" and press [OK] ⑩.
- 9 Follow the messages and make the settings with [▲, ▼, ◀, ▶] ⑨ and [OK] ⑩. (⇒ below, Easy setup settings)
- 10 Press [OK] ⑩ to finish Easy setup.

Easy setup settings

- **Language**
Select the language used on menu screen.
- **TV aspect**
Select the aspect to suit your TV.
- **Speaker layout**
Select "Surround layout (Recommended)" mode or "Front layout (Alternative)" mode according to your speaker layout (⇒ 6, Positioning).
- **Speaker check**
Listen to speaker output to confirm speaker connections.
- **Speaker output**
Make surround sound setting for speaker output.
- **TV audio**
Select the audio input connection from your TV.
For AUX connection (⇒ 7): Select "AUX".
For HDMI connection (⇒ 7): Select "ARC".
For DIGITAL AUDIO IN OPTICAL connection (⇒ 7): Select "DIGITAL IN".
This will be the TV audio setting for VIERA Link "HDAVI Control". (⇒ 14)

Note

- If this unit is connected to a "HDAVI Control 3 or later" compatible TV via HDMI cable, the menu language and TV aspect information will be retrieved via VIERA Link.
- If this unit is connected to a "HDAVI Control 2" compatible TV via HDMI cable, the menu language information will be retrieved via VIERA Link.
- Settings in the Easy setup can also be changed in the player settings [e.g. language, TV aspect, TV audio (⇒ 16)].

Listening to the radio

Presetting stations automatically

Up to 30 stations can be set.

- 1 Press [RADIO, EXT-IN] ⑤ to select "FM".
- 2 Press [MENU] ⑦.
 - Each time you press the button:
LOWEST (factory preset):
To begin auto preset with the lowest frequency.
CURRENT:
To begin auto preset with the current frequency.*
 * To change the frequency, refer to "Manual tuning" (⇒ below).
- 3 Press and hold [OK] ⑩.
 - Release the button when "FM AUTO" is displayed.
 - The tuner starts to preset all the stations it can receive into the channels in ascending order.

- "SET OK" is displayed when the stations are set, and the radio tunes to the last preset station.
- "ERROR" is displayed when automatic presetting is unsuccessful. Preset the stations manually (⇒ below).

Listening/confirming the preset channels

- 1 Press [RADIO, EXT-IN] ⑤ to select "FM".
 - 2 Press the numbered buttons to select a channel.
 - To select a 2-digit number
e.g. 12: [≧10] ③ ⇒ [1] ⇒ [2]
 - Alternatively, press [v, ^] ⑦.
- The FM setting is also shown on the TV display.

If noise is excessive

Press and hold [PLAY MODE] ⑩ to display "MONO".

To cancel the mode, press and hold the button again until "AUTO ST" is displayed.

- The mode is also cancelled when you change the frequency.

Manual tuning

- 1 Press [RADIO, EXT-IN] ⑤ to select "FM".
- 2 Press [SEARCH ◀◀, SEARCH ▶▶] ⑩ to select the frequency.
 - To start automatic tuning, press and hold [SEARCH ◀◀, SEARCH ▶▶] ⑩ until the frequency starts scrolling. Tuning stops when a station is found.

Presetting stations manually

Up to 30 stations can be set.

- 1 While listening to the radio broadcast
Press [OK] ⑩.
- 2 While the frequency is flashing on the display
Press the numbered buttons to select a channel.
 - To select a 2-digit number
e.g. 12: [≧10] ③ ⇒ [1] ⇒ [2]
 - Alternatively, press [v, ^] ⑦, and then press [OK] ⑩.

A station previously stored is overwritten when another station is stored in the same channel preset.

FM frequency step

Main unit only

The step is factory-set to 0.2 MHz, but you can change it to receive broadcasts allocated in 0.1 MHz steps. You may need to change this setting if the tuner seems to skip over the correct frequency for stations in your area.

- 1 Press **[SELECTOR]** to select "FM".
- 2 Press and hold **[MUTE]** (Stop).

After a few seconds the display changes to show the current minimum frequency. Continue to hold the button down. The minimum frequency changes and the step is changed.

e.g. 87.9 (Factory preset) ↔ 87.5

To return to the original step, repeat steps 1 and 2.

Note

After changing the setting, previously preset frequencies will be cleared. Preset them again.

Using the START menu

You can select desired source, change the settings, access playback/menus, etc., by using the START menu.

- 1 Press **[START]** to show the START menu.

- When using VIERA Link "HDAVI Control", the TV also turns on when the START menu is displayed.

e.g.

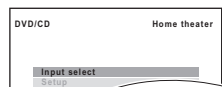

- 2 Press **[▲, ▼]** to select an item and press **[OK]**.

- To exit, press **[START]**.

- 3 Press **[▲, ▼]** to make the setting and press **[OK]**.

When "Input select" is selected

You can select a desired source from the menu.

- DVD/CD (⇒ 11), FM RADIO (⇒ 8), AUX*1 (⇒ below), ARC*1 (⇒ below), DIGITAL IN*1,2 (⇒ below), iPod (⇒ 15)
- *1 "(TV)" will appear beside "AUX", "ARC" or "DIGITAL IN", indicating the TV audio setting for VIERA Link "HDAVI Control" (⇒ 14).
- *2 "(STB)" will appear beside "DIGITAL IN", indicating the STB audio setting for VIERA Link "HDAVI Control" (⇒ 14).

When "Setup" is selected

You can change the settings for this unit. (⇒ 16)

Other selectable items

The items that are displayed will vary depending on the media and source.

When a disc is loaded, you can also access playback or menus from the START menu.

e.g. **[DVD-V]**

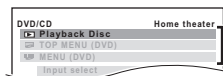

Playback/menu access

When the on-screen control panel appears

e.g. **[DVD-V]** (when "Playback Disc" is selected from the START menu)

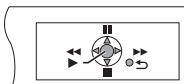

You can operate the playback with the indicated controls.

Selecting the source by the remote control

Press	To select
[DVD]	DVD/CD
[iPod]	IPOD (⇒ 15)
[RADIO, EXT-IN]	Each time you press the button: FM: (⇒ 8) AUX: For audio input through the AUX terminal. ARC: For audio input through the HDMI AV OUT terminal. D-IN: For audio input through the DIGITAL AUDIO IN OPTICAL terminal. (⇒ right)

Note

Confirm the audio connection to the AUX, HDMI AV OUT or DIGITAL AUDIO IN OPTICAL terminal on the main unit when you select the corresponding sources (⇒ 7). Reduce the volume on the TV to its minimum, and then adjust the volume of the main unit.

Listening to the TV or other device's audio from this unit's speakers

Preparation

- Make sure that there is an audio connection between this unit and the TV or other device. (⇒ 7)
- Turn on the TV or/and other device.

Press **[RADIO, EXT-IN]** to choose the source that is used to connect this unit to the TV or other device.

- To change the surround sound effects and sound mode, refer to "Enjoying sound effects from all speakers" (⇒ 10).
- If your Panasonic TV is VIERA Link compatible, refer to "Using the VIERA Link™ "HDAVI Control™" (⇒ 14) for other related functions.

Making settings for digital audio input

Select to suit the type of audio from the DIGITAL AUDIO IN OPTICAL and HDMI AV OUT terminal on the main unit.

Setting must be made for the "D-IN" and "ARC" selector.

- Underlined items are the factory presets.

Available settings	
Mode	Setting
DUAL:	(Only works with Dolby Dual Mono) – <u>MAIN+SAP</u> (stereo audio) – <u>MAIN</u> – <u>SAP</u> "SAP" = Secondary Audio Program • Set PCM FIX mode to "OFF" to listen to the "MAIN" or "SAP" audio.
DRC: (Dynamic Range Compression)	– <u>ON</u> Adjust for clarity even when the volume is low by compressing the range of the lowest sound level and the highest sound level. Convenient for late night viewing. (Only works with Dolby Digital) – <u>OFF</u> The full dynamic range of the signal is reproduced.
PCM FIX:	– <u>ON</u> Select when receiving only PCM signals. – <u>OFF</u> Select when receiving Dolby Digital and PCM signals. • When receiving true 5.1-channel surround sound, select "OFF".
STB*3: (CABLE/SAT AUDIO)	– <u>SET</u> Select when setting the main unit to switch to "D-IN" when the input channel of an HDMI connected STB is selected on the TV (⇒ 14, Setting the STB audio for VIERA Link "HDAVI Control"). – <u>OFF</u> Select to cancel this setting.

- 1 Press **[RADIO, EXT-IN]** several times to select "D-IN" or "ARC".

- 2 Press **[PLAY MODE]** and then **[▲, ▼]** to select the mode.

- 3 While the selected mode is displayed Press **[◀, ▶]** and select the desired setting.

- *3 Only when "D-IN" is selected.

Be sure to select the device's (STB, etc.) input channel on the TV when making the setting.

The device must be connected to the Panasonic TV via an HDMI cable.

Enjoying sound effects from all speakers

- The following sound effects may not be available or may have no effect with some sources.
- You may experience a reduction in sound quality when these sound effects are used with some sources. If this occurs, turn the sound effects off.

Note

When changing the surround sound effect, Whisper-mode Surround or the sound modes, the setting is displayed on the TV screen if "DVD/CD" is the selected source.

Enjoying surround sound effects

Press **[SURROUND]** ⑫.

Each time you press the button:

STANDARD:

Sound is output as it was recorded/encoded. Speaker output varies depending on the source.

MULTI-CH:

You can enjoy sound from the front speakers, as well as the surround speakers even when playing a 2-channel sound.

MANUAL: (⇒ below)

While "MANUAL" is displayed, press **[◀, ▶]** ⑨ to select other surround modes.

Each time you press **[◀, ▶]** ⑨:

DOLBY PLII MOVIE

Suitable for movies, or videos recorded in Dolby Surround.

DOLBY PLII MUSIC

Adds 5.1-channel effects to stereo sources.

S.SRD

You can enjoy sound from all speakers with stereo sources.

STEREO

Sound will only be output to the front speakers and the subwoofer from any source.

Recommended modes to enjoy TV audio or stereo sources from all speakers:

- DOLBY PLII MOVIE
- DOLBY PLII MUSIC
- S.SRD

"SRD" lights in the main unit's display when there is output from the surround speakers.

When the signal is DTS or Dolby Digital, "/DTS" or "/DOLBY DIGITAL" will also be displayed respectively.

Selecting sound mode

1 Press [SOUND] ⑪ to select a sound mode.

Each time you press the button:

EQ: Equalizer

SUBW LVL: Subwoofer Level

H.BASS: Harmonic Bass

C.FOCUS: Center Focus

2 While the selected mode is displayed, press [◀, ▶] ⑨ to make the settings.

Refer to the following for setting details of each sound effect.

EQ (Equalizer)

You can select sound quality settings.

Each time you press **[◀, ▶]** ⑨:

FLAT: Cancel (no effect is added).

HEAVY: Adds punch to rock.

CLEAR: Clarifies higher sounds.

SOFT: For background music.

SUBW LVL (Subwoofer level)

You can adjust the amount of bass. The unit automatically selects the most suitable setting according to the type of playback source.

LEVEL 1 ↔ LEVEL 2 ↔ LEVEL 3 ↔ LEVEL 4

- The setting you make is retained and recalled every time you play the same type of source.

H.BASS (Harmonic Bass)

You can enhance low-frequency sound so that heavy bass sound can be heard clearly, even if the acoustics of your room are not optimal.

ON ↔ OFF

- The setting you make is retained, and recalled every time you play from the same type of source.

C.FOCUS (Center Focus)

[Effective when playing audio containing the center channel sound or when DOLBY PLII (⇒ left) is selected.]

You can make the sound of the center speaker seem like it is coming from within the TV.

ON ↔ OFF

Whisper-mode Surround

You can enhance the audio effect for low volume sound. (Convenient for late night viewing.)

Press **[W.SRD]** ⑬.

Each time you press the button:

ON ↔ OFF

Adjusting the speaker output level manually

Preparation

- To display the picture, turn on the TV and select the appropriate video input mode.
- Press **[+, VOL, -]** ⑭ to adjust the volume to normal listening level.
- Press **[DVD]** ⑮ to select "DVD/CD".
- Select "TEST TONE" from "SPEAKER SETTINGS" in AUDIO menu (⇒ 17).

1 Press [OK] ⑥ to enter test tone mode.

e.g.

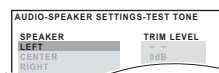

Test tone will be output to each channel in the following order. LEFT, CENTER, RIGHT, SURROUND RIGHT, SURROUND LEFT

2 Press [OK] ⑥ then **[▲, ▼]** ⑧ to adjust the speaker level for each speaker. (CENTER, SURROUND RIGHT, SURROUND LEFT)

-6 dB to +6 dB (Factory preset: 0 dB)

Adjusting the speaker level during playback

(Effective when playing audio containing surround channel sound or when "SRD" lights on the main unit's display)

1 Press and hold [—CH SELECT] ⑩ to select the speaker.

While the speaker channel is displayed, press **[—CH SELECT]** ⑩.

L → C → R → RS → LS → SW

↑

- SW (Subwoofer) is displayed even if the source does not include a subwoofer channel.

2 While "L" or "R" is selected.

Press [◀, ▶] ⑨ to adjust the front speaker balance.

3 While "C", "RS", "LS" or "SW" is selected.

Press [▲] ⑧ (increase) or **[▼]** ⑧ (decrease) to adjust the speaker level for each speaker.

Basic play

Preparation

To display the picture, turn on your TV and change its video input mode (e.g. VIDEO 1, AV 1, HDMI, etc.) to suit the connection to this unit.

- 1 Press [⏻] to turn on the unit.
- 2 Press [DVD] to select "DVD/CD".
- 3 Press [▲ OPEN/CLOSE] to open the disc tray.
- 4 Load the disc.
 - Load double-sided discs so the label for the side you want to play is facing up.
- 5 Press [▶ PLAY] to start play.
 - Press [+ , VOL-, -] to adjust the volume.

Label facing up

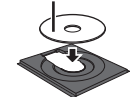

Note

- DISCS CONTINUE TO ROTATE WHILE MENUS ARE DISPLAYED. Press [■ STOP] when you finish to preserve the unit's motor and your TV screen.
- Total title number may not be displayed properly on +R/+RW.

Basic controls

One touch play (remote control only): [▶ PLAY] (during standby mode)

The main unit automatically turns on and starts playing the disc in the tray.

Stop: [■ STOP]

- The position is memorized while "RESUME STOP" is on the screen.
- Press [▶ PLAY] to resume.
- Press [■ STOP] again to clear the position.

Pause: [⏸ PAUSE]

- Press [▶ PLAY] to restart play.

Skip: [SKIP ◀◀, SKIP ▶▶]

Search: [SEARCH ◀◀, SEARCH ▶▶] (during play)

Slow-motion: [SEARCH ◀◀, SEARCH ▶▶] (during pause)

- Up to 5 steps.
- Press [▶ PLAY] to start normal play.
- [VCD] Slow-motion: Forward direction only.

Frame-by-frame: [◀◀II, II▶▶] (during pause)

[DVD-VR] [DVD-V] [VCD]

- [DVD-VR] [VCD] Forward direction only.

On-screen item select: [▲, ▼, ◀, ▶, OK]

[▲, ▼, ◀, ▶] : Select

[OK] : Confirm

Enter number: Numbered buttons

[DVD-VR] [DVD-V] [VCD] [CD]

e.g. To select 12: [≥10] → [1] → [2]

[VCD] with playback control

Press [■ STOP] to cancel the PBC function, and then press the numbered buttons.

[DVD-V] Show a disc top menu: [TOP MENU]

[DVD-V] Show a disc menu: [MENU]

Return to previous screen: [RETURN]

[VCD] (with playback control) Show a disc menu: [RETURN]

Main unit display: [FL DISPLAY]

[DVD-VR] [DVD-V] [WMA] [MP3]

Time display ↔ Information display (e.g. [DVD-VR] Program number)

[JPEG]

SLIDE ↔ Contents number

Other modes of play

Repeat play

This works only when the elapsed play time can be displayed. It also works with all JPEG content.

During play, press and hold [-REPEAT], to show the repeat mode.

While the repeat mode is displayed, press [-REPEAT] to select the item to be repeated.

e.g. [DVD-V]

◀ TITLE → ▶ CHAP. → ▶ OFF

To cancel, select "OFF".

Items shown differ depending on the type of disc and playback mode.

Program and Random play

[DVD-V] [VCD] [CD] [WMA] [MP3] [JPEG]

Preparation

While stopped, press [PLAY MODE] to select the play mode.

Program and random playback screens appear sequentially.

Program → Random

↑ Exit program and random screens ↓

- [DVD-VR] Select "DATA" in "DVD-VR/DATA" (⇒ 17, OTHERS menu) to play WMA, MP3 or JPEG contents.
- For a disc with both WMA/MP3 and JPEG contents, select either music or picture contents
WMA/MP3: Select "MUSIC PROGRAM" or "MUSIC RANDOM".
JPEG: Select "PICTURE PROGRAM" or "PICTURE RANDOM".
- [DVD-V] Some items cannot be played even if you have programmed them.

Program play (up to 30 items)

1 Press [▲, ▼] to select an item and press [OK].

e.g. [DVD-V]

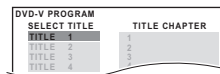

- Repeat this step to program other items.
- To return to the previous menu, press [RETURN].

2 Press [▶ PLAY] to start play.

To select all the items

Press [▲, ▼] to select "ALL" and press [OK].

To clear the selected program

- 1 Press [▶] and then press [▲, ▼] to select the program.
- 2 Press [CANCEL].

To clear the whole program

Press [▶] several times to select "CLEAR ALL", and then press [OK]. The whole program is also cleared when the disc tray is opened, the unit is turned off or another source is selected.

Random play

1 (Only when the disc has groups or multiple titles.)

Press [▲, ▼] to select a group or title and press [OK].

e.g. [DVD-V]

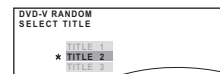

- "*" represents selected. To deselect, press [OK] again.

2 Press [▶ PLAY] to start play.

Using navigation menus

Playing data discs

WMA MP3 JPEG

DVD-VR Select "DATA" in "DVD-VR/DATA" (⇒ 17, OTHERS menu) to play WMA, MP3 or JPEG contents.

Playing from the selected item

You can select to play from your desired item while the "DATA-DISC" screen is displayed.
e.g.

Group (Folder): 

Content (File):

 : WMA/MP3

 : JPEG

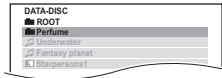

- To display/exit the screen, press [MENU]⑦.

Press [▲, ▼]⑨ to select an item and press [OK]⑩.

- Press [◀, ▶]⑨ to skip page by page.
- To return to 1 level up from the current folder, press [RETURN]⑫.
- Maximum: 28 characters for file/folder name.

Play starts from the selected content.

JPEG Selecting the picture in Thumbnail menu

1 While picture is displayed, press [TOP MENU]⑧ to show the thumbnail menu.

e.g.

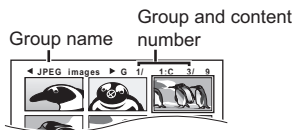

2 Press [▲, ▼, ◀, ▶]⑨ to select a picture and press [OK]⑩.

- Press [SKIP]◀◀, [SKIP]▶▶⑩ to skip page by page.

To go to other group

- 1 Press [▲]⑨ to select the group name.
- 2 Press [◀, ▶]⑨ to select the group and press [OK]⑩.

Playing DVD-R/-RW (DVD-VR) discs

DVD-VR

- Titles appear only if the titles are recorded on the disc.
- You cannot edit programs, play lists and disc titles.

Playing the programs

1 While stopped, press [DIRECT NAVIGATOR]⑧.

e.g.

PG	DATE	LENGTH	TITLE
1	10/11 02:15	0:16:02	LIVE CONCERT
2	12/05 01:30	0:38:25	AUTO ACTION

2 Press [▲, ▼]⑨ to select the program and press [OK]⑩.

- Press [◀, ▶]⑨ to skip page by page.

Playing a play list

This works only when the disc contains a play list.

1 While stopped, press [PLAY LIST]⑦.

e.g.

PL	DATE	LENGTH	TITLE
1	11/11 00:01	0:00:10	CITY PENGUIN
2	12/01 01:20	0:01:20	FOOTBALL

2 Press [▲, ▼]⑨ to select the play list and press [OK]⑩.

- Press [◀, ▶]⑨ to skip page by page.

Using on-screen menus

1 Press [FUNCTIONS]⑳ to show the on-screen menu.

Each time you press the button:

Menu 1 (Disc/Play)

Menu 2 (Video)

Menu 3 (Audio)

Menu 4 (HDMI)

Exit

e.g. [DVD-V] Menu 1 (Disc/Play)

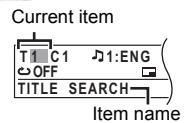

2 Press [▲, ▼, ◀, ▶]⑨ to select the item and press [OK]⑩.

e.g. [DVD-V] Menu 1 (Disc/Play)

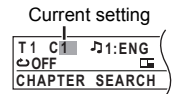

3 Press [▲, ▼]⑨ to make the settings and press [OK]⑩.

Items shown differ depending on the type of disc.

Menu 1 (Disc/Play)

TRACK SEARCH, TITLE SEARCH, CONTENT SEARCH, CHAPTER SEARCH, PG SEARCH (Program Search), PL SEARCH (Playlist Search)

To start from a specific item

- [VCD] This does not work when using playback control.

e.g. [DVD-V]: T2 C5

To select numbers for data disc

e.g. 123: [≥10]③ ⇒ [1] ⇒ [2] ⇒ [3] ⇒ [OK]⑩

AUDIO

[DVD-V] (with multiple soundtracks)

To select audio soundtrack

[DVD-VR] [VCD]

To select "L", "R", "L+R" or "L R"

Actual operations depend on the disc. Read the disc's instructions for details.

Signal type/data

LPCM/PPCM/[D] D/DTS/MP3/MPEG: Signal type
kHz (Sampling frequency)/bit/ch (Number of channels)

e.g.

- 3/2 .1ch
- .1: Low frequency effect
(not displayed if there is no signal)
 - 0: No surround
 - 1: Mono surround
 - 2: Stereo surround (left/right)
 - 1: Center
 - 2: Front left+Front right
 - 3: Front left+Front right+Center

PLAY SPEED

[DVD-VR] [DVD-V]

To change play speed

– from "×0.6" to "×1.4" (in 0.1-unit steps)

- Press [▶] [PLAY]⑥ to return to normal play.

- After you change the speed

– Dolby Pro Logic II has no effect.

– Audio output switches to 2-channel stereo.

– Sampling frequency of 96 kHz is converted to 48 kHz.

- This function may not work depending on the disc's recording.

REPEAT MODE

(⇒ 11, Repeat play)

A-B Repeat (To repeat a specified section)

Except [JPEG] [DVD-VR] (Still picture part) [VCD] (SVCD)

Press [OK]⑩ at the starting and ending points.

- Select "OFF" to cancel.

SUBTITLE

DVD-V (with multiple subtitles) **VCD** (SVCD only)

To select subtitle language

- On +R/+RW, a subtitle number may be shown for subtitles that are not displayed.

DVD-VR (with subtitle on/off information)

To select "ON" or "OFF"

- This may not work depending on the disc.

ANGLE

DVD-V (with multiple angles)

To select a video angle

DATE DISPLAY

JPEG To select "ON" or "OFF" for picture's date display

ROTATION

JPEG To rotate a picture (during pause)

0 ← 90 ← 180 ← 270
↑ ↑ ↑ ↑

Menu 2 (Video)

PICTURE MODE

NORMAL

CINEMA1: Mellows images and enhances detail in dark scenes.

CINEMA2: Sharpens images and enhances detail in dark scenes.

DYNAMIC: Enhances the contrast for powerful images.

ANIMATION: Suitable for animation.

ZOOM

To select zoom sizes

NORMAL, AUTO (**DVD-VR** **DVD-V** **VCD**), ×2, ×4

- **JPEG**: during pause

TRANSFER MODE

If you have chosen "480p"/"720p"/"1080p" or "1080i" ["VIDEO FORMAT" in Menu 4 (HDMI)] select the method of conversion for progressive output to suit the type of material.

- The setting will return to "AUTO1" when the disc tray is opened, the unit is turned off or another source is selected.

AUTO1: Automatically detects the film and video content, and appropriately converts it.

AUTO2: In addition to "AUTO1", automatically detects film contents with different frame rates and appropriately converts it.

VIDEO: Select if the video content is distorted when using "AUTO1" or "AUTO2".

Menu 3 (Audio)

DIALOGUE ENHANCER

To make the dialogue in movies easier to hear

DVD-V (Dolby Digital, DTS, 3-channel or higher, with the dialogue recorded in the center channel)

OFF, ON

Menu 4 (HDMI)

HDMI HDMI STATUS

To show HDMI information

e.g. **DVD-V**

HDMI - INFORMATION		
1	CONNECTED STATE	CONNECTED
2	AUDIO STREAM	PCM
3	MAX CHANNEL	2ch
4	VIDEO FORMAT	720p
5	COLOR SPACE	YCbCr 4:4:4

1 Connection status

2 Shows the output signal type.

(When "OFF" is selected in "AUDIO OUT" (⇒ 17, HDMI menu), "--" will be displayed.)

3 Shows the number of audio channels.

4 (⇒ below, VIDEO FORMAT)

5 (⇒ below, COLOR SPACE)

HD ENHANCER

This works when the HDMI connection is being used with "VIDEO PRIORITY" (⇒ 17, HDMI menu) set to "ON".

To sharpen the "720p", "1080i" and "1080p" picture quality **OFF, 1 (weakest) to 3 (strongest)**

VIDEO FORMAT

This works when the HDMI connection is being used with "VIDEO PRIORITY" (⇒ 17, HDMI menu) set to "ON".

To select suitable picture quality with your TV

(Video recordings will be converted to, and output as, high-definition video.)

480p/720p/1080p (progressive)

480i/1080i (interlaced)

- If the picture is distorted, press and hold [CANCEL]④ until the picture is displayed correctly. (The output will return to "480p".)

COLOR SPACE

This works when the HDMI connection is being used with "VIDEO PRIORITY" (⇒ 17, HDMI menu) set to "ON".

To select suitable picture color with your TV

YCbCr 4:2:2*

- Luminance and color details are sent separately. Most of the picture details are in luminance. The color rate is much higher than composite video. Compatible with all TV models.

YCbCr 4:4:4*

- All color details are sent. Luminance and color details are in the same signal.

RGB*

- Component video type of signal.

※ Terms are descriptions of the sample formats used in digital video. YCbCr is a video signal for luminance (Y), blue (Cb) and red (Cr) details.

- An "*" mark will appear if compatible with your TV.

- If the picture color is distorted, press and hold [CANCEL]④ until the picture color is displayed correctly.

Using the VIERA Link™ “HDAVI Control™”

What is VIERA Link “HDAVI Control”

VIERA Link “HDAVI Control”

VIERA Link™ is a new name for EZ Sync™.

VIERA Link “HDAVI Control” is a convenient function that offers linked operations of this unit, and a Panasonic TV (VIERA) under “HDAVI Control”. You can use this function by connecting the equipment with the HDMI cable. See the operating instructions for connected equipment for operational details.

- VIERA Link “HDAVI Control”, based on the control functions provided by HDMI which is an industry standard known as HDMI CEC (Consumer Electronics Control), is a unique function that we have developed and added. As such, its operation with other manufacturers' equipment that supports HDMI CEC cannot be guaranteed.
- This unit supports “HDAVI Control 5” function. “HDAVI Control 5” is the newest standard (current as of December, 2009) for Panasonic's HDAVI Control compatible equipment. This standard is compatible with Panasonic's conventional HDAVI equipment.
- Please refer to individual manuals for other manufacturers' equipment supporting VIERA Link function.

The TV with “HDAVI Control 2 or later” function enables the following operation: Easy control only with VIERA remote control (for “HDAVI Control 2 or later”) (⇒ 15).

Preparation

- Confirm that the HDMI connection has been made (⇒ 7).
- Set “VIERA Link” to “ON” (⇒ 17, HDMI menu).
- To complete and activate the connection correctly, turn on all VIERA Link “HDAVI Control” compatible equipment and set the TV to the corresponding HDMI input mode for this unit.

Setting the TV audio for VIERA Link “HDAVI Control”

Select “AUX”^{*1}, “ARC”^{*1} or “D-IN”^{*1,2} to work with the linked operations. Refer to TV audio setting in Easy setup (⇒ 8) or “TV AUDIO” in HDMI menu (⇒ 17).

Confirm the audio connection to the AUX terminal (for “AUX”^{*1}), HDMI A/V OUT terminal (for “ARC”^{*1}) or DIGITAL AUDIO IN OPTICAL terminal (for “D-IN”^{*1,2}) (⇒ 7).

Setting the STB audio for VIERA Link “HDAVI Control”

Select “D-IN”^{*1,2} to work with the linked operations. Refer to STB setting in “Making settings for digital audio input” (⇒ 9). Confirm the audio connection to the DIGITAL AUDIO IN OPTICAL terminal (for “D-IN”) (⇒ 7).

Whenever the connection or settings are changed, reconfirm the points above.

- | | |
|----|---|
| ※1 | “AUX”, “ARC” or “D-IN” (DIGITAL IN) works depending on the TV audio setting (⇒ above, Setting the TV audio for VIERA Link “HDAVI Control”). |
| ※2 | “D-IN” (DIGITAL IN) works depending on the STB audio setting (⇒ above, Setting the STB audio for VIERA Link “HDAVI Control”). |

What you can do with “HDAVI Control”

Auto lip sync

(Available when using VIERA Link “HDAVI Control” with “HDAVI Control 3 or later” compatible TV)

This function automatically provides synchronized audio and video output. (This works only when the source is “DVD/CD”, “AUX”^{*1}, “ARC”^{*1} or “D-IN”^{*1,2}.)

- When using “DVD/CD” as the source, set “TIME DELAY” in VIDEO menu to “0 ms/AUTO” (⇒ 16).

One touch play

You can turn the main unit and the TV on, and start playing a disc with a single press of a button.

(Remote control only)

During standby mode, press **▶ PLAY [6] to start disc playback.**

This unit's speakers will be automatically activated (⇒ right).

Note

Playback may not be immediately displayed on the TV. If you miss the beginning portion of playback, press [SKIP ◀◀] [6] or [SEARCH ◀◀] [6] to go back to where playback started.

Auto input switching (Power on link)

When the following operations are performed, the TV will automatically switch the input channel and display the corresponding action.

Additionally when the TV is off, the TV will automatically turn on:

- When play starts on the unit
- When an action that uses the display screen is performed (e.g., START menu)
- When you switch the TV input to TV tuner mode, this unit will automatically switch to “AUX”^{*1}, “ARC”^{*1} or “D-IN”^{*1,2}. (For “IPOD” mode, this works only in iPod music mode, or when iPod is not connected.)
- When you start disc play, the TV will automatically switch its input mode for this unit.

Power off link

All connected equipment compatible with “HDAVI Control”, including this unit, automatically turn off when you switch the TV off.

To continue audio playback even when the TV is turned off, select “VIDEO” (⇒ 17, “POWER OFF LINK” in HDMI menu).

Note

When you press [⏻] [1], only this unit turns off. Other connected equipment compatible with VIERA Link “HDAVI Control” stays on.

For details, refer also to the operating instructions for your TV.

Speaker control

You can select whether audio is output from this unit's speakers or the TV speakers by using the TV menu settings. For details, refer to the operating instructions for your TV.

Home theater

This unit's speakers are active.

- When you turn on this unit, this unit's speakers will be automatically activated.
- When this unit is in standby mode, changing the TV speakers to this unit's speakers in the TV menu will automatically turn this unit on and select “AUX”^{*1}, “ARC”^{*1} or “D-IN”^{*1,2} as the source.
- The TV speakers are automatically muted.
- You can control the volume setting using the volume or mute button on the TV's remote control. (The volume level is displayed on the main unit's display.)
- To cancel muting, you can also use this unit's remote control (⇒ 4).
- If you turn off this unit, TV speakers will be automatically activated.

TV

TV speakers are active.

- The volume of this unit is set to “0”.
 - This function works only when “DVD/CD”, “AUX”^{*1}, “ARC”^{*1} or “D-IN”^{*1,2} is selected as the source on this unit.
- Audio output is 2-channel audio.

When switching between this unit speakers and TV speakers, the TV screen may be blank for several seconds.

Easy control only with VIERA remote control (for "HDAVI Control 2 or later")

You can control the playback menus of this unit with the TV's remote control. When operating the TV's remote control, refer to the below illustration for operation buttons.

- 1 Select this unit's operation menu by using the TV menu settings. (For details, refer to the operating instructions for your TV.) The START menu will be shown. e.g. **DVD-V**



- The START menu can also be shown by using a button on the TV's remote control (e.g. [SUB MENU]).
 - When "DVD/CD" is selected as the source, the TV's remote control works only during stop mode.
 - This feature does not work while the iPod music playback screen is displayed on the TV.

- 2 Select the desired item on the START menu (⇒ 9).

When the on-screen control panel appears e.g. **DVD-V** (when "Playback Disc" is selected from the START menu.)

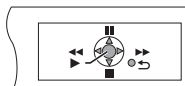

- You can operate the playback with the indicated controls.
- The on-screen control panel can also be shown by using a button on the TV's remote control (e.g. [SUB MENU]).
 - This works only during "DVD/CD" playback and resume modes or, while the iPod music playback screen is displayed on the TV.

Note

- Depending on the menu, some button operations cannot be performed from the TV's remote control.
- You cannot input numbers with the numbered buttons on the TV's remote control ([0] to [9]). Use this unit's remote control to select the play list etc.

Using the iPod

You can enjoy iPod music through this unit's speakers or view iPod videos/photos on the TV.

Preparation

- To view photos/videos from the iPod
 - Ensure the video connection to the VIDEO OUT terminal on this unit (⇒ 7).
 - Operate the iPod menu to make the appropriate photo/video output settings for your TV. (Refer to operating instructions of your iPod.)
- To display the picture, turn on the TV and select the appropriate video input mode.
- Before connecting/disconnecting the iPod, turn the main unit off or reduce the volume of the main unit to its minimum.

- 1 Push Δ to open the Dock for iPod lid.

- 2 Connect the iPod (not included) firmly.

- Attach the dock adapter which should be supplied with your iPod to the dock for the stable use of the iPod. If you need an adapter, consult your iPod dealer.

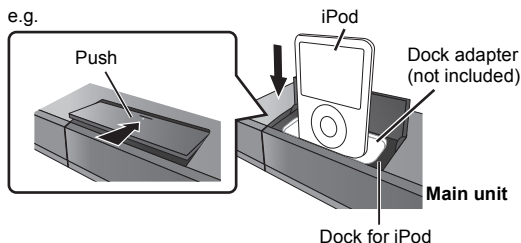

- 3 Press [iPod] to select "IPOD".

The iPod automatically switches to this unit's display mode. e.g.



- 4 Press [FUNCTIONS] to select the menu.

Each time you press the button:
 Music menu → Video menu
 ↑ iPod menu (iPod LCD) ↓

When using the START menu in "IPOD" mode e.g.

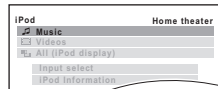

- Music:** Shows the music menu.
- Videos:** Shows the video menu.
- All (iPod display):** Switches to iPod menu.
- iPod Information:** Display iPod details.

Enjoying music/videos

- 1 Press [FUNCTIONS] to select music or video menu on the TV.

- 2 Press [Δ , ∇] to select an item and press [OK].

- Press [\leftarrow , \rightarrow] to skip page by page.
- To return to the previous screen, press [RETURN].

Play starts from the selected song or video. e.g. music playback screen

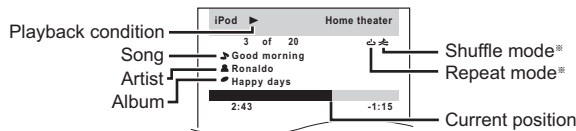

※ These icons will only appear for music mode.



Basic controls (For music and videos only)

Button	Function
[PLAY]	Play
[STOP], [PAUSE]	Pause
[SKIP $\leftarrow\leftarrow$, SKIP $\rightarrow\rightarrow$]	Skip
(press and hold) [SKIP $\leftarrow\leftarrow$, SKIP $\rightarrow\rightarrow$]	Search

Other methods of playback

Shuffle mode (For music playback only)

Press [PLAY MODE] several times.

SONGS, ALBUMS, OFF

Repeat mode

Press and hold [REPEAT] and then press the button several times within a few seconds.

During the music/video playback: ONE, ALL, OFF

Note

- Music playback modes set on the iPod will be maintained when connected to the main unit. Changes made while the iPod is connected to the main unit will be kept on the iPod after disconnecting it.
- If the video menu is accessed, the video shuffle playback mode on the iPod is set to off when the iPod is disconnected from the unit.

1 Press [FUNCTIONS]Ⓜ to select the iPod menu.

2 Play a slideshow on your iPod.

- You can use the remote control to operate the iPod menu.
- [▲, ▼]Ⓜ: To navigate menu items.
- [OK]Ⓜ: To go to the next menu.
- [RETURN]Ⓜ: To return to the previous menu.

The remote control operation may vary between iPod models.

While an iPod is connected

Do not push or pull your iPod back and forth with great force.

About recharging the battery

- iPod will start recharging regardless of whether this unit is on or off.
- "iPOD *" will be shown on the main unit's display during iPod charging in main unit standby mode.
- Check iPod to see if the battery is fully recharged.
- If you are not using iPod for an extended period of time after recharging has completed, disconnect it from main unit, as the battery will be depleted naturally. (Once fully recharged, additional recharging will not occur.)

Compatible iPod

- iPod nano 5th generation (video camera) (8GB, 16GB)
- iPod touch 2nd generation (8GB, 16GB, 32GB, 64GB)
- iPod classic [120GB, 160GB (2009)]
- iPod nano 4th generation (video) (8GB, 16GB)
- iPod classic [160GB (2007)]
- iPod touch 1st generation (8GB, 16GB, 32GB)
- iPod nano 3rd generation (video) (4GB, 8GB)
- iPod classic (80GB)
- iPod nano 2nd generation (aluminum) (2GB, 4GB, 8GB)
- iPod 5th generation (video) (60GB, 80GB)
- iPod 5th generation (video) (30GB)
- iPod nano 1st generation (1GB, 2GB, 4GB)
- iPod 4th generation (color display) (40GB, 60GB)
- iPod 4th generation (color display) (20GB, 30GB)
- iPod 4th generation (40GB)
- iPod 4th generation (20GB)
- iPod mini (4GB, 6GB)

Compatibility depends on the software version of your iPod.

To use the iPod touch features

- Press the Home button on the iPod touch.
- Select the iPod touch features on the touch screen to operate.

Changing the player settings

1 Press [DVD]Ⓜ to select "DVD/CD".

2 Press [START]Ⓜ to show the START menu.

3 Press [▲, ▼]Ⓜ to select "Setup" and press [OK]Ⓜ.

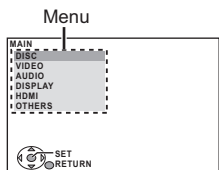

4 Press [▲, ▼]Ⓜ to select menu and press [OK]Ⓜ.

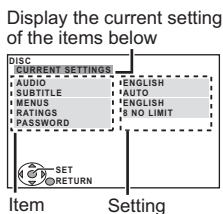

5 Press [▲, ▼]Ⓜ to select the item and press [OK]Ⓜ.

6 Press [▲, ▼]Ⓜ to make the settings and press [OK]Ⓜ.

- To return to the previous screen, press [RETURN]Ⓜ.
- To exit the screen, press [START]Ⓜ.
- The settings remain intact even if you switch the unit to standby.

• Underlined items are the factory settings in the following menus.

DISC menu

AUDIO

Choose the audio language.

- ENGLISH • FRENCH • SPANISH
- ORIGINAL*1 • OTHER ---#2

SUBTITLE

Choose the subtitle language.

- AUTO*3 • ENGLISH • FRENCH • SPANISH
- OTHER ---#2

MENUS

Choose the language for disc menus.

- ENGLISH • FRENCH • SPANISH
- OTHER ---#2

- *1 The original language designated on the disc is selected.
- *2 Input the appropriate code from the language code list (⇒ 19).
- *3 If the language selected for "AUDIO" is not available, subtitles appear in that language (if available on the disc).

RATINGS

Set a rating level to limit DVD-Video play.

Setting ratings (When level 8 is selected)

- 0 LOCK ALL: To prevent play of discs without rating levels.
- 1 to 7
- 8 NO LIMIT

When you select your ratings level, a password screen is shown.

Follow the on-screen instructions.

Do not forget your password.

A message screen will be shown if a DVD-Video disc exceeding the rating level is inserted in the unit.

Follow the on-screen instructions.

PASSWORD

Change the password for "RATINGS".

- SETTING

To change ratings (When level 0 to 7 is selected)

- CHANGE: Follow the on-screen instructions.

VIDEO menu

TV ASPECT

Choose the setting to suit your TV.

- 16:9: Widescreen TV (16:9)
- 4:3PAN&SCAN: Regular aspect TV (4:3)
The sides of the widescreen picture are cut off so it fills the screen (unless prohibited by the disc).
- 4:3LETTERBOX: Regular aspect TV (4:3)
Widescreen picture is shown in the letterbox style.



TIME DELAY

When connected with a Plasma display, adjust if you notice the audio is out of sync with the video.

- 0 ms/AUTO • 20 ms • 40 ms • 60 ms
- 80 ms • 100 ms

When using VIERA Link "HDMI Control" with "HDMI Control 3 or later" compatible TV (⇒ 14), select "0 ms/AUTO".

Audio and video will automatically be set in sync.

STILL MODE

Specify the type of picture shown when paused.

- AUTO
- FIELD: The picture is not blurred, but picture quality is lower.
- FRAME: Overall quality is high, but the picture may appear blurred.

BLACK LEVEL

Change the black level of the picture.

- LIGHTER
- DARKER

AUDIO menu

Select to suit the type of equipment you connected to the HDMI AV OUT terminal.

Select "BITSTREAM" when the equipment can decode the bitstream (digital form of 5.1-channel data). Otherwise, select "PCM". (If the bitstream is output to the equipment without a decoder, high levels of noise can be output and may damage your speakers and hearing.)

DOLBY DIGITAL*

- **BITSTREAM**
- **PCM**

DTS*

- **BITSTREAM**
- **PCM**

* When audio is output from HDMI AV OUT terminal, and the connected equipment does not support the item selected, the actual output will depend on the performance of this connected equipment.

DYNAMIC RANGE

- **ON**: Adjusts for clarity even when the volume is low. Convenient for late night viewing. (Only works with Dolby Digital)
- **OFF**

SPEAKER SETTINGS

Select the delay time of the speakers.

(Center and surround speakers only)

For optimum listening with 5.1-channel sound, all the speakers, except for the subwoofer, should be the same distance from the seating position.

If you have to place the center or surround speakers closer to the seating position, adjust the delay time to make up for the difference.

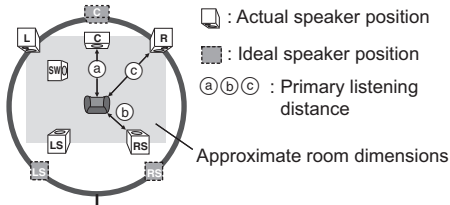

Circle of constant primary listening distance

If either distance (a) or (b) is less than (c), find the difference in the table and change to the recommended setting.

a) Center speaker		b) Surround speaker	
Difference (Approx.)	Setting	Difference (Approx.)	Setting
30 cm (1 foot)	1ms	150 cm (5 feet)	5ms
60 cm (2 feet)	2ms	300 cm (10 feet)	10ms
90 cm (3 feet)	3ms	450 cm (15 feet)	15ms
120 cm (4 feet)	4ms		
150 cm (5 feet)	5ms		

● SETTINGS:

- **C DELAY (Center Delay):**
0ms, 1ms, 2ms, 3ms, 4ms, 5ms
Select the delay time for your center speaker.
- **LS/RS DELAY (Left Surround/Right Surround Delay):**
0ms, 5ms, 10ms, 15ms
Select the delay time for your surround speakers.
- **TEST TONE: SETTING**
Use the test tone for speaker level adjustments (⇒ 10, Adjusting the speaker output level manually).

DISPLAY menu

LANGUAGE

Choose the language for the on-screen messages.

- **ENGLISH**
- **FRANÇAIS**
- **ESPAÑOL**

HDMI menu

VIDEO PRIORITY

- **ON**: When using the HDMI AV OUT terminal for video output. The resolution of the video output from the HDMI AV OUT terminal is optimized according to the capability of the connected equipment (e.g. TV).
- **OFF**: When not using the HDMI AV OUT terminal for video output.

AUDIO OUT

- **ON**: When audio output is from the HDMI AV OUT terminal. (Depending on the capabilities of the connected equipment, audio output may differ from the audio settings of the main unit.)
- **QEE**: When audio output is not from the HDMI AV OUT terminal. (The audio is output using the settings of the main unit.)

RGB RANGE

This works only when "COLOR SPACE" in Menu 4 (HDMI) is set to RGB (⇒ 13).

- **STANDARD**
- **ENHANCED**: When the black and white images are not distinct.

VIERA Link

- **ON**: The VIERA Link "HDAVI Control" function is available (⇒ 14).
- **OFF**

POWER OFF LINK

Select the desired power off link setting of this unit for VIERA Link operation (⇒ 14). (This works depending on the settings of the connected VIERA Link "HDAVI Control" compatible equipment.)

- **VIDEO/AUDIO**: When the TV is turned off, this unit will turn off automatically.
- **VIDEO**: When the TV is turned off, this unit will turn off except during the following conditions:
 - audio playback (CD MP3 WMA)
 - iPod mode
 - radio mode
 - "AUX", "ARC" or "D-IN" mode (non-selected TV audio setting for VIERA Link)

TV AUDIO

Select the TV audio input to work with the VIERA Link operations (⇒ 14).

- **AUX**
- **ARC**
- **DIGITAL IN**

OTHERS menu

SLIDE SHOW TIME

Set the speed of the slideshow.

Factory preset: 3 SEC

- 1 SEC to 15 SEC (in 1-unit steps)
- 15 SEC to 60 SEC (in 5-unit steps)
- 60 SEC to 180 SEC (in 30-unit steps)

FL DIMMER

Change the brightness of the unit's display.

- **BRIGHT**
- **DIM**: The display is dimmed.
- **AUTO**: The display is dimmed, but brightens when you perform some operations.

FL CONTROL

- **ON (VOL 0)**: The unit's display will turn off when the volume is adjusted to "0".
- **OFF**

EASY SETUP

- **SET (⇒ 8)**

DVD-VR/DATA

Select to play only DVD-VR or DATA format.

- **DVD-VR**: To play the video programs on DVD-R/RW.
- **DATA**: To play the data files on DVD-R/RW.

SCREEN DIMMER

This is to prevent burn marks on the TV screen.

- **OFF**
- **WAIT 5 MIN**: If there is no operation for 5 minutes, the picture turns gray. The TV screen will resume when you perform some operations. (This does not work during video and picture playback.)

DEFAULTS









This returns all values in the MAIN menu to the default settings.

● RESET













The password screen is shown if "RATINGS" (⇒ 16) is set. Please enter the same password, then turn the unit off and on again.

Discs that can be played

Commercial discs

Type of media/ Logo	Remarks	Indicated as
 	High quality movie and music discs	
 	Music discs with video Including SVCD (Conforming to IEC62107)	
	Music discs	

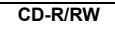
Recorded discs

Type of media/ Logo	Formats	Indicated as
 	<ul style="list-style-type: none"> ● DVD-Video Format ● Version 1.1 of the DVD Video Recording Format ● MP3 format ● JPEG format 	   
	<ul style="list-style-type: none"> ● DVD-Video Format ● Version 1.2 of the DVD Video Recording Format 	 
	<ul style="list-style-type: none"> ● +VR (+R/+RW Video Recording) Format 	
	<ul style="list-style-type: none"> ● MP3 format ● JPEG format ● WMA 	  

- Before playback, finalize the disc on the device it was recorded on.
- It may not be possible to play all the above-mentioned discs in some cases due to the type of disc, the condition of the recording, the recording method, or how the files were created (⇒ right, Tips for making data discs).

Note about using a DualDisc

The digital audio content side of a DualDisc does not meet the technical specifications of the Compact Disc Digital Audio (CD-DA) format so playback may not be possible.

Discs that cannot be played

Blu-ray, HD DVD, AVCHD discs, DVD-RW version 1.0, DVD-Audio, DVD-ROM, CD-ROM, CDV, CD-G, SACD, DivX Video Discs and Photo CD, DVD-RAM, and "Chaoji VCD" available on the market including CVD, DVCD and SVCD that do not conform to IEC62107.

Disc handling precautions

- Do not attach labels or stickers to discs. This may cause disc warping, rendering it unusable.
- Do not write on the label side with a ball-point pen or other writing instrument.
- Do not use record cleaning sprays, benzene, thinner, liquids which prevent static electricity, or any other solvent.
- Do not use scratch-proof protectors or covers.
- Do not use the following discs:
 - Discs with exposed adhesive from removed stickers or labels (rented discs, etc.).
 - Discs that are badly warped or cracked.
 - Irregularly shaped discs, such as heart shapes.

Tips for making data discs

WMA (Extension: ".WMA", ".wma")

Disc: CD-R/RW

- Compatible compression rate: between 48 kbps and 320 kbps
- You cannot play WMA files that are copy-protected.

MP3 (Extension: ".MP3", ".mp3")

Disc: DVD-R/RW, CD-R/RW

- This unit does not support ID3 tags.
- Sampling frequency and compression rate:
 - DVD-R/RW: 11.02 kHz, 12 kHz, 22.05 kHz, 24 kHz (8 kbps to 160 kbps), 44.1 kHz and 48 kHz (32 kbps to 320 kbps)
 - CD-R/RW: 8 kHz, 11.02 kHz, 12 kHz, 16 kHz, 22.05 kHz, 24 kHz (8 kbps to 160 kbps), 32 kHz, 44.1 kHz and 48 kHz (32 kbps to 320 kbps)

JPEG (Extension: ".JPG", ".jpg", ".JPEG", ".jpeg")

Disc: DVD-R/RW, CD-R/RW

- JPEG files taken on a digital camera that conform to DCF Standard (Design rule for Camera File system) Version 1.0 are displayed.
 - Files that have been altered, edited or saved with computer picture editing software may not be displayed.
- This unit cannot display moving pictures, MOTION JPEG and other such formats, still pictures other than JPEG (e.g. TIFF), or play pictures with attached audio.

- There may be differences in the display order on the menu screen and computer screen.
- This unit cannot play files recorded using packet write.

DVD-R/RW

- Discs must conform to UDF bridge (UDF 1.02/ISO9660).
- This unit does not support multi-session. Only the default session is played.

CD-R/RW

- Discs must conform to ISO9660 level 1 or 2 (except for extended formats).
- This unit supports multi-session but if there are many sessions it takes more time for play to start. Keep the number of sessions to a minimum to avoid this.

Maintenance

Clean this unit with a soft, dry cloth

- Never use alcohol, paint thinner or benzene to clean this unit.
- Before using chemically treated cloth, carefully read the instructions that came with the cloth.

Do not use commercially available lens cleaners as they may cause malfunction. Cleaning of the lens is generally not necessary although this depends on the operating environment.

Before moving the unit, ensure the disc tray is empty. Failure to do so will risk severely damaging the disc and the unit.

Speaker installation option

Attaching to a wall

You can attach all of the speakers (except subwoofer) to a wall.

- The wall or pillar on which the speakers are to be attached should be capable of supporting 10 kg (22 lbs) per screw. Consult a qualified building contractor when attaching the speakers to a wall. Improper attachment may result in damage to the wall and speakers.

1 Drive a screw (not included) into the wall.

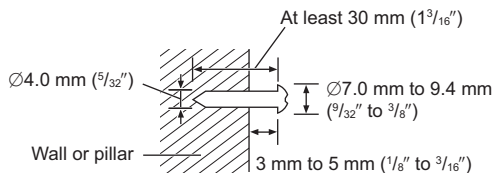

2 Fit the speaker securely onto the screw(s) with the hole(s).

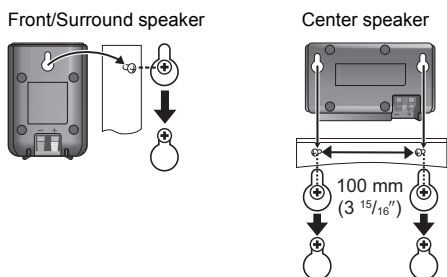

Language code list

Abkhazian: 6566	Danish: 6865	Italian: 7384	Norwegian: 7879	Swedish: 8386
Afar: 6565	Dutch: 7876	Japanese: 7465	Oriya: 7982	Tagalog: 8476
Afrikaans: 6570	English: 6978	Javanese: 7487	Pashto, Pushto: 8083	Tajik: 8471
Albanian: 8381	Esperanto: 6979	Kannada: 7578	Persian: 7065	Tamil: 8465
Amharic: 6577	Estonian: 6984	Kashmiri: 7583	Polish: 8076	Tatar: 8484
Arabic: 6582	Faroese: 7079	Kazakh: 7575	Portuguese: 8084	Telugu: 8469
Armenian: 7289	Fiji: 7074	Kirghiz: 7589	Punjabi: 8065	Thai: 8472
Assamese: 6583	Finnish: 7073	Korean: 7579	Quechua: 8185	Tibetan: 6679
Aymara: 6589	French: 7082	Kurdish: 7585	Rhaeto-Romance: 8277	Tigrinya: 8473
Azerbaijani: 6590	Frisian: 7089	Laotian: 7679	Romanian: 8279	Tonga: 8479
Bashkir: 6665	Galician: 7176	Latin: 7665	Russian: 8285	Turkish: 8482
Basque: 6985	Georgian: 7565	Latvian, Lettish: 7686	Samoan: 8377	Turkmen: 8475
Bengali, Bangla: 6678	German: 6869	Lingala: 7678	Sanskrit: 8365	Twi: 8487
Bhutani: 6890	Greek: 6976	Lithuanian: 7684	Scots Gaelic: 7168	Ukrainian: 8575
Bihari: 6672	Greenlandic: 7576	Macedonian: 7775	Serbian: 8382	Urdu: 8582
Breton: 6682	Guarani: 7178	Malagasy: 7771	Serbo-Croatian: 8372	Uzbek: 8590
Bulgarian: 6671	Gujarati: 7185	Malay: 7783	Shona: 8378	Vietnamese: 8673
Burmese: 7789	Hausa: 7265	Malayalam: 7776	Sindhi: 8368	Volapük: 8679
Byelorussian: 6669	Hebrew: 7387	Maltese: 7784	Singhalese: 8373	Welsh: 6789
Cambodian: 7577	Hindi: 7273	Maori: 7773	Slovak: 8375	Wolof: 8779
Catalan: 6765	Hungarian: 7285	Marathi: 7782	Slovenian: 8376	Xhosa: 8872
Chinese: 9072	Icelandic: 7383	Moldavian: 7779	Somali: 8379	Yiddish: 7473
Corsican: 6779	Indonesian: 7378	Mongolian: 7778	Spanish: 6983	Yoruba: 8979
Croatian: 7282	Interlingua: 7365	Nauru: 7865	Sundanese: 8385	Zulu: 9085
Czech: 6783	Irish: 7165	Nepali: 7869	Swahili: 8387	

Troubleshooting guide

Before requesting service, make the following checks. If you are in doubt about some of the check points, or if the solutions indicated in the following guide do not solve the problem, refer to "Customer Services Directory (United States and Puerto Rico)" on page 24 if you reside in the U.S.A. or Puerto Rico, or refer to "Product information" on page 23 if you reside in Canada.

Power

No power.

Insert the AC power supply cord securely. (⇒ 7)

The unit is automatically switched to standby mode.

- The Sleep timer was working and had reached the set time limit. (⇒ 4)
- This unit will automatically turn to standby mode after 30 minutes if it is inactive. (⇒ 4)

Power of this unit is turned off when the input for the TV is changed.

This is a normal phenomenon when using VIERA Link "HDAVI Control 4 or later". For details please read the operating instructions of the TV.

Unit displays

The display is dark.

Select "BRIGHT" in "FL DIMMER" in the OTHERS menu. (⇒ 17)

"NO PLAY"

- You inserted a disc the unit cannot play; insert one it can. (⇒ 18)
- You inserted a blank disc.
- You inserted a disc that has not been finalized.

"NO DISC"

- You have not inserted a disc; insert one.
- You have not inserted the disc correctly; insert it correctly. (⇒ 11)

"IPOD OVER CURRENT ERROR"

The iPod is drawing too much power. Remove the iPod, and turn the unit off and on again.

"F61"

Check and correct the speaker cable connections. If this does not fix the problem, consult the dealer. (⇒ 6)

"F76"

There is a power supply problem. Consult the dealer.

"DVD U11"

Disc may be dirty. Wipe it clean.

"ERROR"

Incorrect operation performed. Read the instructions and try again.

"DVD H□□"

"DVD F□□□"

- stands for a number.
- Trouble may have occurred. The numbers following "H" and "F" depend on the status of the unit. Turn the unit off and then back on. Alternatively, turn the unit off, disconnect the AC power supply cord, and then reconnect it.
- If the service numbers fail to clear, note the service number and contact a qualified service person.

"U70□"

- stands for a number. (The actual number following "U70" will depend on the state of the main unit.)
- The HDMI connection acts unusually.
 - The connected equipment is not HDMI-compatible.
 - Please use HDMI cables that have the HDMI logo (as shown on the cover).
 - The HDMI cable is too long.
 - The HDMI cable is damaged.

"REMOTE 1" or "REMOTE 2"

Match the modes on the main unit and remote control. Depending on the number being displayed ("1" or "2"), press and hold [OK]Ⓢ and the corresponding numbered button ([1] or [2]) for at least 2 seconds. (⇒ 4)

"LOADING"

- The iPod is not ready. Wait for this display to disappear.
- Disconnect the iPod, and then reconnect it firmly. (⇒ 15)

General operation

No response when any buttons are pressed.

- This unit cannot play discs other than the ones listed in these operating instructions. (⇒ 18)
- The unit may not be operating properly due to lightning, static electricity or some other external factor. Turn the unit off and then back on. Alternatively, turn the unit off, disconnect the AC power supply cord, and then reconnect it.
- Condensation has formed. Wait 1 to 2 hours for it to evaporate.

No response when remote control buttons are pressed.

- Check that the batteries are installed correctly. (⇒ 7)
- The batteries are depleted. Replace them with new ones. (⇒ 7)
- Aim the remote control at the remote control signal sensor and operate. (⇒ 4)

Other products respond to the remote control.

Change the remote control operating mode. (⇒ 4)

Cannot display the START menu.

Remove the disc and then press [START]Ⓢ again.

No picture or sound.

- Check the video or speaker connection. (⇒ 6, 7)
- Check the power or input setting of the connected equipment and the main unit.
- Check that the disc has something recorded on it.

You have forgotten your ratings password.

Reset all the settings to Factory Preset. While stopped and "DVD/CD" is the source, press and hold [■]Ⓢ (Stop) on the main unit and [≧10]Ⓢ on the remote control until "INITIALIZED" disappears from the TV. Turn the unit off and on again. All settings will return to the default values. (This does not work during program and random modes, or when setup menu or START menu is displayed.)

Some characters are not displayed correctly.

Characters other than English alphabet and Arabic numerals may not be displayed correctly.

The VIERA Link "HDAVI Control" function does not respond.

Depending on the condition of this unit or the connected equipment, it may be necessary to repeat the same operation so that the function can work correctly. (⇒ 14)

The setting you made in "TV ASPECT" (⇒ 16, VIDEO menu) or "LANGUAGE" (⇒ 17, DISPLAY menu) does not work.

The settings for "TV ASPECT"^{*1} and "LANGUAGE"^{*2} will automatically follow the information from the TV. (⇒ 8, Easy setup settings)

- ※1 When using VIERA Link "HDAVI Control" with "HDAVI Control 3 or later" compatible TV
- ※2 When using VIERA Link "HDAVI Control" with "HDAVI Control 2 or later" compatible TV

Disc operation

It takes time before play starts. [MP3]

Play may take time to begin when an MP3 track has still picture data. Even after the track starts, the correct play time will not be displayed. This is normal.

A menu screen appears during skip or search. [VCD]

This is normal for Video CDs.

Playback control menu does not appear.

[VCD] with playback control
Press [■ STOP]Ⓢ twice and then press [▶ PLAY]Ⓢ.

Program and Random play do not work. [DVD-V]

These functions do not work with some DVD-Videos.

Play does not start.

- This unit may not play WMA that contains still picture data.
- If a disc contains CD-DA and other formats, proper playback may not be possible.

No subtitles.

Display the subtitles. ("SUBTITLE" in Menu 1) (⇒ 13)

Point B is automatically set.

The end of an item becomes point B when it is reached.

The Setup menu cannot be accessed.

Select "DVD/CD" as the source.

Sound

Sound is distorted.

- Noise may occur when playing WMA.
- When using the HDMI output, audio may not be output from other terminals.

Effects do not work.

Some audio effects do not work or have less effect with some discs.

Humming is heard during play.

An AC power supply cord or fluorescent light is near the main unit. Keep other appliances and cables away from the main unit.

No sound.

- There may be a slight pause in sound when you change the play speed.
- If the input source is bitstream, set the sound setting to PCM on the external equipment.

No sound from the TV.

- If the TV is not ARC compatible and only the HDMI connection is used, an extra audio connection is necessary. (⇒ 7)
- Confirm the audio connection. Press [RADIO, EXT-IN]Ⓞ to select the corresponding source. (⇒ 7, 9)
- When using the HDMI connection, ensure that "AUDIO OUT" in the HDMI menu is set to "ON". (⇒ 17)

No sound from the surround speakers.

Press [SURROUND]Ⓜ to select "MULTI-CH". (⇒ 10)

Picture

The picture on the TV is not displayed correctly or disappears.

- Ensure that the unit is connected directly to the TV, and is not connected through a VCR. (⇒ 7)
- Mobile telephone chargers can cause some disturbance.
- If you are using an indoor TV antenna, change to an outdoor antenna.
- The TV antenna wire is too close to the unit. Move it away from the unit.
- Reduce the number of connected HDMI devices.
- When using the HDMI AV OUT terminal, ensure that an incompatible video output with the connected TV is not selected. Press and hold [CANCEL]Ⓞ until the picture is displayed correctly. (The output will return to "480p".) (⇒ 13)
- Video images converted to 1920×1080 resolution may look different from the true native 1080p full-HD sources. This is not a malfunction of the main unit.

Picture size does not fit the screen.

- Change "TV ASPECT" in the VIDEO menu. (⇒ 16)
- Use the TV to change the aspect.
- Change the zoom setting. ("ZOOM" in Menu 2) (⇒ 13)

Menu is not displayed correctly.

Restore the zoom ratio to "NORMAL". ("ZOOM" in Menu 2) (⇒ 13)

Auto zoom function does not work well.

- Turn off TV's zoom function.
- Zoom function may not work well, especially in dark scenes and may not work depending on the type of disc.

iPod operation

Cannot charge or operate.

- Check that the iPod is connected firmly. (⇒ 15)
- The battery of the iPod is depleted. Charge the iPod, and then operate again.

Cannot display iPod photos/videos on the TV.

- Ensure the video connection to the VIDEO OUT terminal on this unit. (⇒ 7)
- Operate the iPod menu to make the appropriate photo/video output settings for your TV. (Refer to operating instructions for your iPod.)

HDMI progressive video

There is ghosting when HDMI progressive output is on.

This problem is caused by the editing method or material used on DVD-Video, but should be corrected if you use interlaced output. When using the HDMI AV OUT terminal, set "VIDEO FORMAT" in Menu 4 to "480i". Or, disable the HDMI connection and use the other video connection. (⇒ 7, 13)

Closed captions not displayed.

When HDMI progressive output is used, closed captions will not be displayed.

Radio

Distorted sound or noise is heard.

- Adjust the position of the FM antenna.
- Use an outdoor antenna. (⇒ 6)

A beat sound is heard.

Turn the TV off or move it away from the unit.

TV displays

"Ⓞ"

The operation is prohibited by the unit or disc.

"THIS DISC CANNOT BE PLAYED IN YOUR REGION."

Only DVD-Video discs that include or have the same region number as the one on the rear panel of this unit can be played. (⇒ Cover page)

"No Video"

Depending on the connected iPod, video menu may not be available on the TV.

Select iPod menu (iPod LCD) mode (⇒ 15) and operate video playback from your iPod menu.

Specifications

AMPLIFIER SECTION

RMS Output Power: Dolby Digital Mode

Front Ch	125 W per channel (3 Ω), 1 kHz, 10 % THD
Surround Ch	125 W per channel (3 Ω), 1 kHz, 10 % THD
Center Ch	250 W per channel (6 Ω), 1 kHz, 10 % THD
Subwoofer Ch	250 W per channel (6 Ω), 100 Hz, 10 % THD
Total RMS Dolby Digital mode power	1000 W

FTC Output Power: Dolby Digital Mode

Front Ch	60 W per channel (3 Ω), 120 Hz to 20 kHz, 1 % THD
Surround Ch	60 W per channel (3 Ω), 120 Hz to 20 kHz, 1 % THD
Center Ch	106 W per channel (6 Ω), 120 Hz to 20 kHz, 1 % THD
Subwoofer Ch	100 W per channel (6 Ω), 45 Hz to 120 Hz, 1 % THD
Total FTC Dolby Digital mode power	446 W

FM TUNER, TERMINALS SECTION

Preset Memory FM 30 stations

Frequency Modulation (FM)

Frequency range	87.9 MHz to 107.9 MHz (200-kHz step) 87.5 MHz to 108.0 MHz (100-kHz step)
Antenna terminals	75 Ω (unbalanced)

Digital audio input

Optical digital input	Optical terminal
Sampling frequency	32 kHz, 44.1 kHz, 48 kHz

DISC SECTION

Discs played [8 cm (3") or 12 cm (5")]

- DVD (DVD-Video)
- DVD-R (DVD-Video, DVD-VR, MP3^{2,5}, JPEG^{4,5})
- DVD-R DL (DVD-Video, DVD-VR)
- DVD-RW (DVD-Video, DVD-VR, MP3^{2,5}, JPEG^{4,5})
- +R/+RW (Video)
- +R DL (Video)
- CD, CD-R/RW (CD-DA, Video CD, SVCD¹, MP3^{2,5}, WMA^{3,5}, JPEG^{4,5})
 - ※1 Conforming to IEC62107
 - ※2 MPEG-1 Layer 3, MPEG-2 Layer 3
 - ※3 Windows Media Audio Ver.9.0 L3
Not compatible with Multiple Bit Rate (MBR)
 - ※4 Exif Ver 2.1 JPEG Baseline files
Picture resolution: between 160×120 and 6144×4096 pixels (Sub sampling is 4:0:0, 4:2:0, 4:2:2 or 4:4:4). Extremely long and narrow pictures may not be displayed.
 - ※5 The total combined maximum number of recognizable audio and picture contents and groups: 4000 audio and picture contents and 255 groups. (Excluding Root folder)

Pick up

Wavelength (DVD/CD)	655/790 nm
Laser power	For U.S.A. CLASS II For Canada CLASS 1M

Audio output (Disc)

Number of channels	5.1 ch (FL, FR, C, SL, SR, SW)
--------------------	--------------------------------

VIDEO SECTION

Video system NTSC

Composite video output

Output level	1 Vp-p (75 Ω)
Terminal	Pin jack (1 system)

HDMI AV output

Terminal	19-pin type A connector
----------	-------------------------

HDAVI Control This unit supports "HDAVI Control 5" function.

SPEAKER SECTION

Front speakers SB-HF480

Type	1 way, 1 speaker system (Bass reflex)
Speaker unit(s)	Impedance 3 Ω
Full range	6.5 cm (2 ¹ / ₂ ") Cone type
Output sound pressure	78 dB/W (1.0 m)
Frequency range	105 Hz to 25 kHz (−16 dB) 130 Hz to 22 kHz (−10 dB)
Dimensions (W×H×D)	80 mm×119 mm×68 mm (3 ⁵ / ₃₂ "×4 ¹¹ / ₁₆ "×2 ¹¹ / ₁₆ ")
Mass [Weight]	0.4 kg (0.88 lbs)

Surround speakers SB-HS480

Type	1 way, 1 speaker system (Bass reflex)
Speaker unit(s)	Impedance 3 Ω
Full range	6.5 cm (2 ¹ / ₂ ") Cone type
Output sound pressure	78 dB/W (1.0 m)
Frequency range	105 Hz to 25 kHz (−16 dB) 130 Hz to 22 kHz (−10 dB)
Dimensions (W×H×D)	80 mm×119 mm×68 mm (3 ⁵ / ₃₂ "×4 ¹¹ / ₁₆ "×2 ¹¹ / ₁₆ ")
Mass [Weight]	0.4 kg (0.88 lbs)

Center speaker SB-HC480

Type	1 way, 1 speaker system (Bass reflex)
Speaker unit(s)	Impedance 6 Ω
Full range	6.5 cm (2 ¹ / ₂ ") Cone type
Output sound pressure	79 dB/W (1.0 m)
Frequency range	90 Hz to 25 kHz (−16 dB) 115 Hz to 22 kHz (−10 dB)
Dimensions (W×H×D)	145 mm×85 mm×71.5 mm (5 ²³ / ₃₂ "×3 ¹¹ / ₃₂ "×2 ¹³ / ₁₆ ")
Mass [Weight]	0.6 kg (1.32 lbs)

Subwoofer SB-HW480

Type	1 way, 1 speaker system (Bass reflex)
Speaker unit(s)	Impedance 6 Ω
Woofer	16 cm (6 ¹ / ₂ ") Cone type
Output sound pressure	78 dB/W (1.0 m)
Frequency range	40 Hz to 220 Hz (−16 dB) 45 Hz to 180 Hz (−10 dB)
Dimensions (W×H×D)	145 mm×289.5 mm×258 mm (5 ²³ / ₃₂ "×11 ¹³ / ₃₂ "×10 ⁵ / ₃₂ ")
Mass [Weight]	2.8 kg (6.17 lbs)

GENERAL

Power supply	AC 120 V, 60 Hz
Power consumption	Main unit 90 W
Dimensions (W×H×D)	430 mm×54 mm×287 mm (16 ¹⁵ / ₁₆ "×2 ¹ / ₈ "×11 ⁵ / ₁₆ ")
Mass [Weight]	Main unit 2.7 kg (6.0 lbs)
Operating temperature range	0 °C to +40 °C (+32 °F to +104 °F)
Operating humidity range	35 % to 80 % RH (no condensation)

Power consumption in standby mode	approx. 0.2 W
--	---------------

Note

- Specifications are subject to change without notice. Mass and dimensions are approximate.
- Total harmonic distortion is measured by a digital spectrum analyzer.

Licenses

Manufactured under license from Dolby Laboratories. Dolby, Pro Logic, and the double-D symbol are trademarks of Dolby Laboratories.

Manufactured under license under U.S. Patent #'s: 5,451,942; 5,956,674; 5,974,380; 5,978,762; 6,487,535 & other U.S. and worldwide patents issued & pending. DTS and the Symbol are registered trademarks & DTS Digital Surround and the DTS logos are trademarks of DTS, Inc. Product includes software. © DTS, Inc. All Rights Reserved.

U.S. Patent Nos. 6,836,549; 6,381,747; 7,050,698; 6,516,132; and 5,583,936.

This product incorporates copyright protection technology that is protected by U.S. patents and other intellectual property rights. Use of this copyright protection technology must be authorized by Macrovision, and is intended for home and other limited viewing uses only unless otherwise authorized by Macrovision. Reverse engineering or disassembly is prohibited.

Windows Media and the Windows logo are trademarks or registered trademarks of Microsoft Corporation in the United States and/or other countries.

This product is protected by certain intellectual property rights of Microsoft Corporation and third parties. Use or distribution of such technology outside of this product is prohibited without a license from Microsoft or an authorized Microsoft subsidiary and third parties.

HDMI, the HDMI logo and High-Definition Multimedia Interface are trademarks or registered trademarks of HDMI Licensing LLC.

HDAVI Control™ is a trademark of Panasonic Corporation.

VIERA Link™ is a trademark of Panasonic Corporation.

EZ Sync™ is a trademark of Panasonic Corporation.



"Made for iPod" means that an electronic accessory has been designed to connect specifically to iPod and has been certified by the developer to meet Apple performance standards. Apple is not responsible for the operation of this device or its compliance with safety and regulatory standards. iPod is a trademark of Apple Inc., registered in the U.S. and other countries.

Product Service

- 1. Damage requiring service**—The unit should be serviced by qualified service personnel if:
 - (a) The AC power supply cord or AC adaptor has been damaged; or
 - (b) Objects or liquids have gotten into the unit; or
 - (c) The unit has been exposed to rain; or
 - (d) The unit does not operate normally or exhibits a marked change in performance; or
 - (e) The unit has been dropped or the cabinet damaged.
- 2. Servicing**—Do not attempt to service the unit beyond that described in these operating instructions. Refer all other servicing to authorized servicing personnel.
- 3. Replacement parts**—When parts need replacing ensure the servicer uses parts specified by the manufacturer or parts that have the same characteristics as the original parts. Unauthorized substitutes may result in fire, electric shock, or other hazards.
- 4. Safety check**—After repairs or service, ask the servicer to perform safety checks to confirm that the unit is in proper working condition.

The servicer will require all components to service your system. Therefore, should service ever be necessary, be sure to bring the entire system.

Product information

For product information or assistance with product operation:

In the U.S.A. and Puerto Rico, refer to "Customer Services Directory (United States and Puerto Rico)" on page 24.

In Canada, contact the Panasonic Canada Inc. Customer Care Centre at 1-800-561-5505, or visit the website (www.panasonic.ca), or an authorized Servicentre closest to you.

Limited Warranty (ONLY FOR U.S.A. AND PUERTO RICO)

Panasonic Consumer Electronics Company,
Division of Panasonic Corporation of North America
One Panasonic Way, Secaucus, New Jersey 07094

Panasonic Home Audio Products Limited Warranty

Limited Warranty Coverage (For USA and Puerto Rico Only)

If your product does not work properly because of a defect in materials or workmanship, Panasonic Consumer Electronics Company (referred to as "the warrantor") will, for the length of the period indicated on the chart below, which starts with the date of original purchase ("warranty period"), at its option either (a) repair your product with new or refurbished parts, (b) replace it with a new or a refurbished equivalent value product, or (c) refund your purchase price. The decision to repair, replace or refund will be made by the warrantor.

Product or Part Name	Parts	Labor
Audio Products (except items below)	1 year	1 year
DVD Home Theater System	1 year	1 year
USB Reader-writer, PC Card Adapters (defective exchange)	1 year	Not Applicable
Accessories: Headphones, cartridges, Microphones, Adapters	90 days	90 days
Rechargeable Batteries, DVD-RAM Disc (defective exchange)	10 days	Not Applicable
SD Memory Cards, Rechargeable Battery Packs (defective exchange)	90 days	Not Applicable

During the "Labor" warranty period there will be no charge for labor. During the "Parts" warranty period, there will be no charge for parts. This Limited Warranty excludes both parts and labor for non-rechargeable batteries, antennas, and cosmetic parts (cabinet). This warranty only applies to products purchased and serviced in the United States or Puerto Rico. This warranty is extended only to the original purchaser of a new product which was not sold "as is".

Carry-In or Mail-In Service

To find a service center please visit <http://www.panasonic.com/help> or call 1-800-211-PANA (7262).

When shipping the unit, carefully pack, include all accessories, and send it prepaid, adequately insured and preferably in the original carton. If Lithium Ion batteries are shipped by air the package must be labeled "Contains Lithium Ion Battery (No lithium metal)". Damaged batteries are prohibited from shipment by US Mail. Batteries must be securely packed in a manner to prevent short-circuiting and a package cannot contain more than 3 Lithium Ion batteries. Include a letter detailing the complaint, a return address and provide a daytime phone number where you can be reached. A valid registered receipt is required under the Limited Warranty.

IF REPAIR IS NEEDED DURING THE WARRANTY PERIOD, THE PURCHASER WILL BE REQUIRED TO FURNISH A SALES RECEIPT/ PROOF OF PURCHASE INDICATING DATE OF PURCHASE, AMOUNT PAID AND PLACE OF PURCHASE. CUSTOMER WILL BE CHARGED FOR THE REPAIR OF ANY UNIT RECEIVED WITHOUT SUCH PROOF OF PURCHASE.

Limited Warranty Limits And Exclusions

This warranty ONLY COVERS failures due to defects in materials or workmanship, and DOES NOT COVER normal wear and tear or cosmetic damage. The warranty ALSO DOES NOT COVER damages which occurred in shipment, or failures which are caused by products not supplied by the warrantor, or failures which result from accidents, misuse, abuse, neglect, mishandling, misapplication, alteration, faulty installation, set-up adjustments, misadjustment of consumer controls, improper maintenance, power line surge, lightning damage, modification, introduction of sand, humidity or liquids, commercial use such as hotel, office, restaurant, or other business or rental use of the product, or service by anyone other than a Factory Service Center or other Authorized Servicer, or damage that is attributable to acts of God.

THERE ARE NO EXPRESS WARRANTIES EXCEPT AS LISTED UNDER "LIMITED WARRANTY COVERAGE". THE WARRANTOR IS NOT LIABLE FOR INCIDENTAL OR CONSEQUENTIAL DAMAGES RESULTING FROM THE USE OF THIS PRODUCT, OR ARISING OUT OF ANY BREACH OF THIS WARRANTY. (As examples, this excludes damages for lost time, travel to and from the servicer, loss of or damage to media or images, data or other memory or recorded content. The items listed are not exclusive, but for illustration only.)

ALL EXPRESS AND IMPLIED WARRANTIES, INCLUDING THE WARRANTY OF MERCHANTABILITY, ARE LIMITED TO THE PERIOD OF THE LIMITED WARRANTY.

Some states do not allow the exclusion or limitation of incidental or consequential damages, or limitations on how long an implied warranty lasts, so the exclusions may not apply to you.

This warranty gives you specific legal rights and you may also have other rights which vary from state to state. If a problem with this product develops during or after the warranty period, you may contact your dealer or Service Center. If the problem is not handled to your satisfaction, then write to the warrantor's Consumer Affairs Department at the addresses listed for the warrantor.

PARTS AND SERVICE, WHICH ARE NOT COVERED BY THIS LIMITED WARRANTY, ARE YOUR RESPONSIBILITY.

Customer Services Directory (United States and Puerto Rico)

Obtain Product Information and Operating Assistance; locate your nearest Dealer or Service Center; purchase Parts and Accessories; or make Customer Service and Literature requests by visiting our Web Site at:

<http://www.panasonic.com/help>

or, contact us via the web at:

<http://www.panasonic.com/contactinfo>

You may also contact us directly at:

1-800-211-PANA (7262)

Monday-Friday 9am-9pm, Saturday-Sunday 10am-7pm EST

For hearing or speech impaired TTY users, TTY: 1-877-833-8855

Accessory Purchases (United States and Puerto Rico)

Purchase Parts, Accessories and Instruction Books online for all Panasonic Products by visiting our Web Site at:

<http://www.pstc.panasonic.com>

Or, send your request by E-mail to:

npcparts@us.panasonic.com

You may also contact us directly at:

1-800-332-5368 (Phone) 1-800-237-9080 (Fax Only)

(Monday-Friday 9am-9pm EST)

Panasonic Service and Technology Company

20421 84th Avenue South, Kent, WA 98032

(We accept Visa, MasterCard, Discover Card, American Express, and Personal Checks)

For hearing or speech impaired TTY users, TTY: 1-866-605-1277

As of November 2009

Limited Warranty (ONLY FOR CANADA)

Panasonic Canada Inc.

PANASONIC PRODUCT – LIMITED WARRANTY

Panasonic Canada Inc. warrants this product to be free from defects in material and workmanship and agrees to remedy any such defect for a period as stated below from the date of original purchase.

Technics Audio Product	One (1) year, parts and labour
Panasonic Portable / Clock Radio (without Tape, CD, MD)	One (1) year, parts and labour
Panasonic Audio / SD Audio Product	One (1) year, parts and labour
Panasonic DVD Product	One (1) year, parts and labour
Panasonic Combination DVD Player / VCR	One (1) year, parts and labour
Panasonic Combination DVD Recorder / VCR	One (1) year, parts and labour
Accessories including rechargeable batteries	Ninety (90) days

LIMITATIONS AND EXCLUSIONS

This warranty does not apply to products purchased outside Canada or to any product which has been improperly installed, subjected to usage for which the product was not designed, misused or abused, damaged during shipping, or which has been altered or repaired in any way that affects the reliability or detracts from the performance, nor does it cover any product which is used commercially. Dry cell batteries are also excluded from coverage under this warranty.

This warranty is extended to the original end user purchaser only. A purchase receipt or other proof of date of original purchase is required before warranty service is performed.

THIS EXPRESS, LIMITED WARRANTY IS IN LIEU OF ALL OTHER WARRANTIES, EXPRESS OR IMPLIED, INCLUDING ANY IMPLIED WARRANTIES OF MERCHANTABILITY AND FITNESS FOR A PARTICULAR PURPOSE.

IN NO EVENT WILL PANASONIC CANADA INC. BE LIABLE FOR ANY SPECIAL, INDIRECT OR CONSEQUENTIAL DAMAGES.

In certain instances, some jurisdictions do not allow the exclusion or limitation of incidental or consequential damages, or the exclusion of implied warranties, so the above limitations and exclusions may not be applicable.

WARRANTY SERVICE

FOR PRODUCT OPERATION ASSISTANCE, please contact:

Our Customer Care Centre:	Telephone #:	(905) 624-5505
	1-800 #:	1-800-561-5505
	Fax #:	(905) 238-2360
	Email link:	"Customer support" on www.panasonic.ca

FOR PRODUCT REPAIRS, please locate your nearest Authorized Servicentre at www.panasonic.ca :

Link : "Servicentres™ locator" under "Customer support"

IF YOU SHIP THE PRODUCT TO A SERVICENTRE

Carefully pack and send prepaid, adequately insured and preferably in the original carton.

Include details of the defect claimed, and proof of date of original purchase.

-If you see this symbol-

Information on Disposal in other Countries outside the European Union



This symbol is only valid in the European Union.
If you wish to discard this product, please contact your local authorities or dealer and ask for the correct method of disposal.

User memo:

DATE OF PURCHASE _____
DEALER NAME _____
DEALER ADDRESS _____
TELEPHONE NUMBER _____

The model number and serial number of this product can be found on either the back or the bottom of the unit.
Please note them in the space provided below and keep for future reference.

MODEL NUMBER _____ SC-PT480
SERIAL NUMBER _____

CAUTION	- LASER RADIATION WHEN OPEN. DO NOT STARE INTO BEAM. FDA 21 CFR / Class II
CAUTION	- CLASS 1M IRISIBLE AND INVISIBLE LASER RADIATION WHEN OPEN. DO NOT VIEW DIRECTLY INTO OPTICAL INSTRUMENTS. IEC60825-1 +A2 / Class 1M
WARNING	- KLASS 1M SYNLIS OCH OSYNLIG LASERSTRÅLNING NÄR DENNA DEL ÄR ÖPPNAD. BETRÄKTA EJ STRÅLEN DIREKT GENOM OPTISKT INSTRUMENT.
FORSIGTIG	- SYNLIG OG USYNLIG LASERSTRÅLNING KLASSE 1M. NÄR LAGET ER ÅBENT, UNDGÅ AT SE LIGE PÅ MED OPTISKE INSTRUMENTER.
VARO!	- AVATTAESSA OLET ALTIINNA LUOKAN 1M NÄKYVÄÄ JA NÄKYMÄTÖNTÄ, LASERSÄTELYÄ, ÄLÄ KATSO OPTISELLÄ LÄITTELLÄ SUORAAN SATEESEEN.
VORSICHT	- SICHTBARE UND UNSICHTBARE LASERSTRAHLUNG KLASSE 1M. WENN ABEDECKUNG GEÖFFNET, NICHT DIREKT MIT OPTISCHEN INSTRUMENTEN BETRACHTEN.
ATTENTION	- RAYONNEMENT LASER VISIBLE ET INVISIBLE, CLASSE 1M, EN CAS D'OUVERTURE. NE PAS REGARDER DIRECTEMENT À L'ŒIL DES INSTRUMENTS D'OPTIQUE.
注意	- 灯照射時可见及不可见激光辐射。避免光照射。 GB7241.1-2001/GB 类 ROLXS0075

(Inside of product)

For U.S.A. and Puerto Rico

Panasonic Consumer Electronics Company, Division of Panasonic Corporation of North America
One Panasonic Way, Secaucus, New Jersey 07094
<http://www.panasonic.com>

For Canada

Panasonic Canada Inc.
5770 Ambler Drive
Mississauga, Ontario
L4W 2T3
www.panasonic.ca

En