

Isometric

	<u>Models:</u>	<u>Models:</u>
	3010RE	3450TS
<u>Models:</u>	3185RL	3595RE
Rushmore	3455RL	3650RL
Key Largo	3585RL	3690SL
San Antonio	3670RL	3510RL
Grand Canyon	3685RL	3070RE
Monterey	3855FL	3950FB
Savanna	3570RS	3150RL
	3875FB	3160EL

Notes:
1. View Is From The Backside.

Heartland RV LLC claims a copyright and proprietary rights to this document and the information contained herein. It is proprietary information and confidential. This drawing may not be reproduced or given to any unauthorized agent, nor can anything be manufactured with its information without written consent from Heartland RV LLC.	Rev	Description	Date	ECN#	Title: <i>Refrigerator, Face Frame, RM1350</i> <i>See Usage</i>	Date:	05/09/07
	L	Revised Usage	11/30/10	N/A		Drawn By:	SL
	M	Change to Norcold Refer, removed face 'B'	12/27/11	N/A		Sheet:	1 of 3
	N	Added model: 3570RS	06/12/12	N/A		File No.	ATC-5289
	O	Added model: 3070RE	10/03/12	N/A		Drawing No.	ATC-5289
P	Added model: Monterey	11/20/12	N/A	Heartland RV LLC			
Q	Added model: 3875FB	01/09/13	N/A				
R	Added model: 3950FB	5/28/13	N/A				
S	Added model: 3150RL	8/29/13	N/A				
T	Added model: 3160EL	10/01/13	N/A				

TOLERANCE
Decimal: ± 0.01
Fractional: ± 1/16"
Degree: ± 1°
DO NOT SCALE

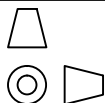

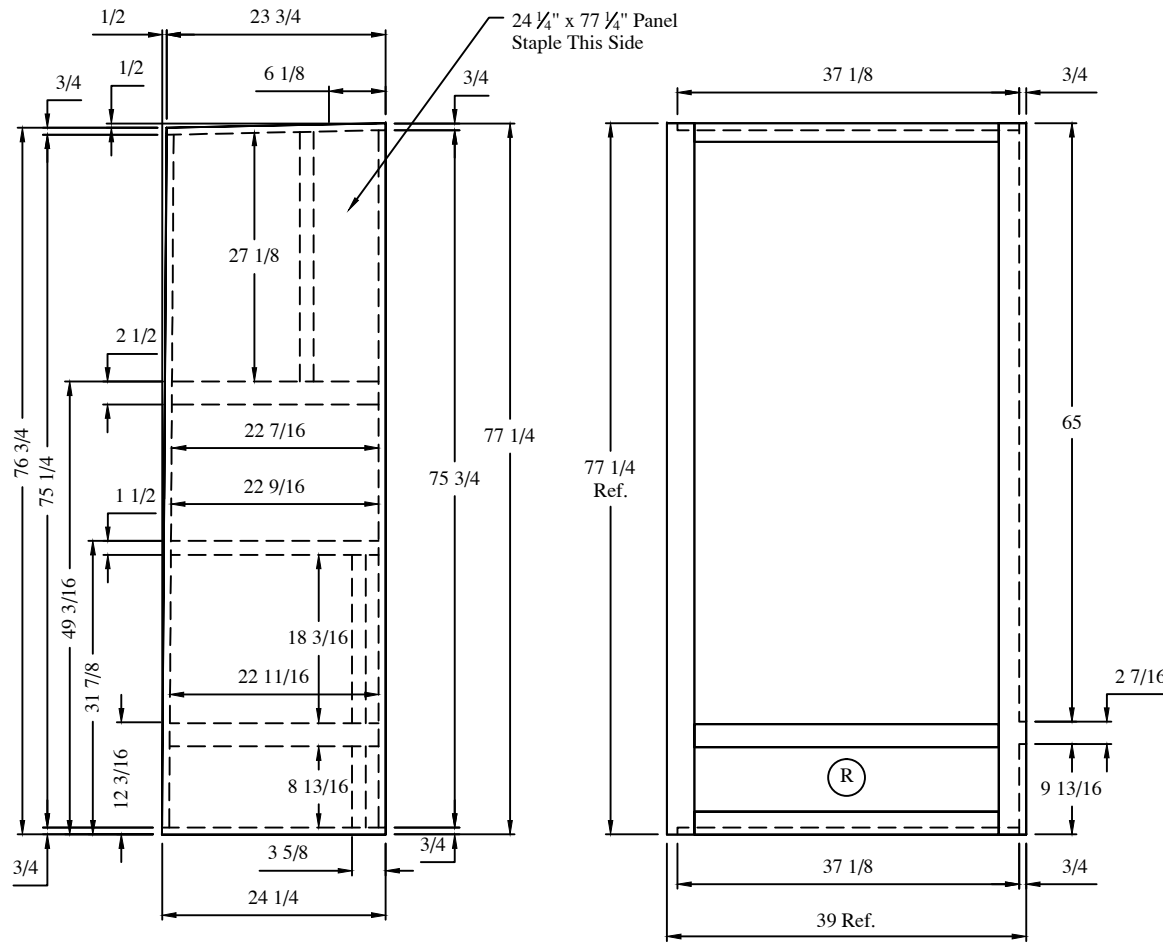

LH End Panel
(Cleat Stock w/ Panel)

Face - A
3/4" Stiles w/ Cleat Stock

Models:	Models:
3010RE	3450TS
3185RL	3595RE
Rushmore	3455RL
Key Largo	3650RL
San Antonio	3585RL
Grand Canyon	3670RL
Monterey	3685RL
Savanna	3070RE
	3855FL
	3950FB
	3570RS
	3150RL
	3875FB
	3160EL

- Notes:
1. View Is From The Front And Outside.
 2. FOS = Flush Opposite Side.
 3. FTS = Flush This Side.

Heartland RV LLC claims a copyright and proprietary rights to this document and the information contained herein. It is proprietary information and confidential. This drawing may not be reproduced or given to any unauthorized agent, nor can anything be manufactured with its information without written consent from Heartland RV LLC

TOLERANCE
Decimal: ± 0.01
Fractional: ± 1/16"
Degree: ± 1°
DO NOT SCALE

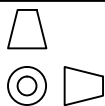

Rev	Description	Date	ECN#
L	Revised Usage	11/30/10	N/A
M	Change to Norcold Refer, removed face 'B'	12/27/11	N/A
N	Added model: 3570RS	06/12/12	N/A
O	Added model: 3070RE	10/03/12	N/A
P	Added model: Monterey	11/20/12	N/A
Q	Added model: 3875FB	01/09/13	N/A
R	Added model: 3950FB	5/28/13	N/A
S	Added model: 3150RL	8/29/13	N/A
T	Added model: 3160EL	10/01/13	N/A

Title: **Refrigerator, Assembly, RM1350**
See Usage

Date: **05/09/07**

Drawn By: **SL**

Sheet: **2 of 3**

Heartland RV LLC

File No.

ATC-5289

Drawing No.

ATC-5289

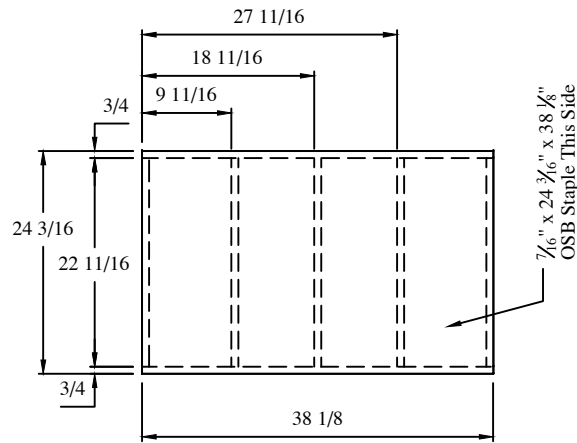

Shelf- "A"
(3/4" x 1 1/2" On Edge)

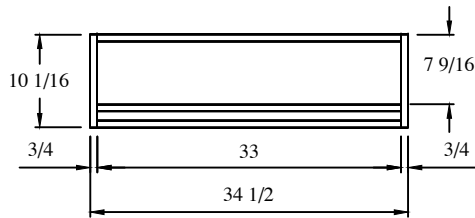

Guide Ladder
(3/4" x 1 1/2" On Edge)

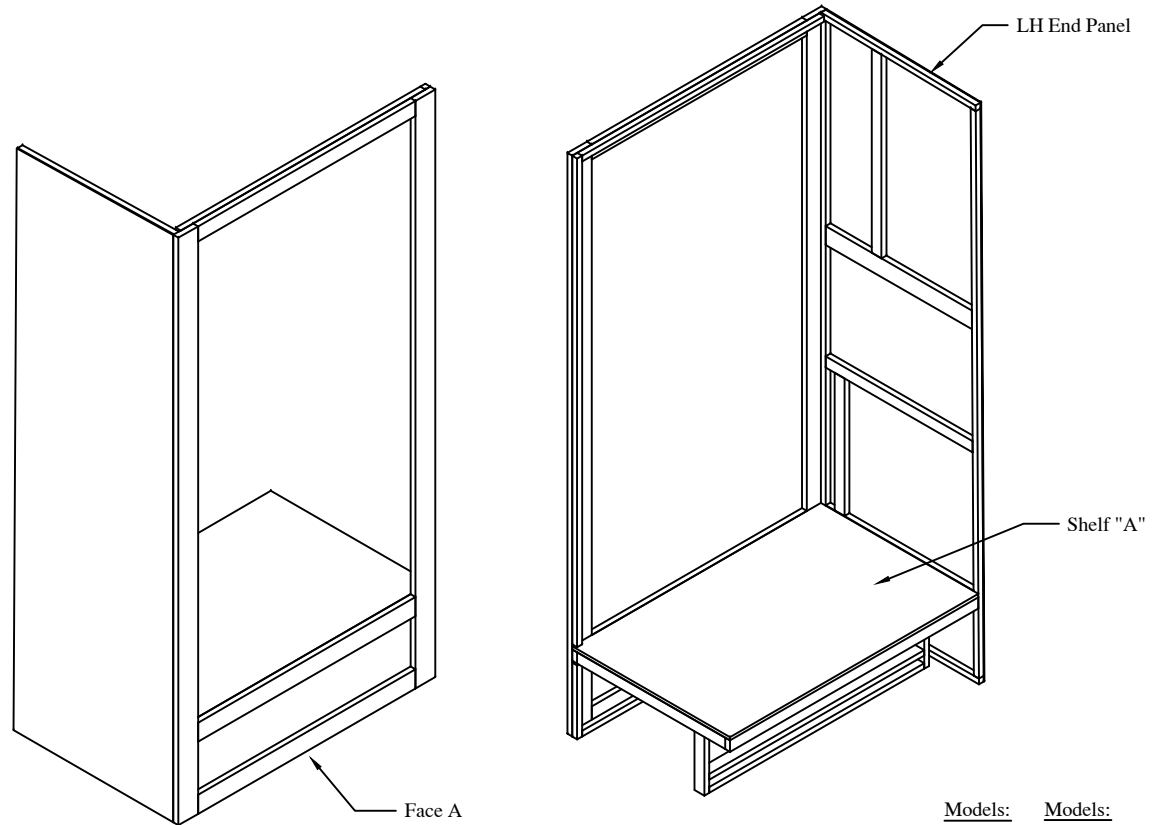

Isometric

<u>Models:</u>	<u>Models:</u>
3010RE	3450TS
3185RL	3595RE
Rushmore	3455RL
Key Largo	3585RL
San Antonio	3670RL
Grand Canyon	3685RL
Monterey	3855FL
Savanna	3570RS
3875FB	3150RL
	3160EL

Heartland RV LLC claims a copyright and proprietary rights to this document and the information contained herein. It is proprietary information and confidential. This drawing may not be reproduced or given to any unauthorized agent, nor can anything be manufactured with its information without written consent from Heartland RV LLC

Rev	Description	Date	ECN#
L	Revised Usage	11/30/10	N/A
M	Change to Norcold Refer, removed face 'B'	12/27/11	N/A
N	Added model: 3570RS	06/12/12	N/A
O	Added model: 3070RE	10/03/12	N/A
P	Added model: Monterey	11/20/12	N/A
Q	Added model: 3875FB	01/09/13	N/A
R	Added model: 3950FB	5/28/13	N/A
S	Added model: 3150RL	8/29/13	N/A
T	Added model: 3160EL	10/01/13	N/A

Title: *Refrigerator, Assembly, RM1350*
See Usage

Date: *05/09/07*

Drawn By: *SL*

Sheet: *3 of 3*

TOLERANCE
Decimal: ± 0.01
Fractional: ± 1/16"
Degree: ± 1°
DO NOT SCALE

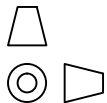

Heartland RV LLC

File No.

ATC-5289

Drawing No.

ATC-5289